



SUPPLEMENTAL SPRINKLER EXAM MATERIAL

For ASCR2, ASCR4, ASC2, ASR2, ASD2

This document is required for the exams indicated above. Print this document and make sure it is bound in a binder.



This document shall be used to study and taken to the exam.

**This Document
Includes the
Following
Required for
Exams:**

**Viking and Reliable
Sprinkler Head Data**

**Spears CPVC
Installation Manual**

**OSHA Guidance on
Elevator Pits**

**OSHA Confined
Space and Control of
Hazardous Energy
(LOTO)**

**COMPLIANCE
SERVICES &
ASSESSMENTS, LC**

Info@CSAexams.com

www.CSAexams.com

Updated: 9/6/2020
Revised: NA

SUMMARY OF INFORMATION IN BOOKLET

The Viking and Reliable sprinkler data sheets in this handout will be incorporated into questions to evaluate the installers' ability to apply criteria and installation instructions specific to the listing of sprinkler heads. This criteria may vary depending on each sprinkler head. Thus, the installer needs to make sure they have the necessary data for the sprinklers they will be installing. These data sheets will be identified by questions starting with [Sprinkler Data].

The Spears manual in this handout will be used for questions related to the installation of CPVC plastic sprinkler piping. Much of the limitations around CPVC piping is based on the product listing. Thus, use of the installation manual is necessary for CPVC installations.

OSHA has issued an interpretation letter with regards to working in elevator pits. Because many elevator pits have sprinklers, this OSHA information is included for installers to understand their position with these hazards.

A booklet outlining OSHA criteria for confined spaces has been included due to the hazards that sprinkler contractors may encounter with these spaces. Although this document is of an older printing, it provides a good overview of hazards and protection necessary for confined spaces.

Two OSHA pages are included which summarize some key points dealing with the control of hazardous energy sources, often referred to as Lock-Out-Tag-Out or LOTO. These hazards are associated with electrical energy, water under pressure, air under pressure, and moving components such as fire pumps and compressors. Additional information is provided in a separate document under our Test Info page.

Make sure to study this information and take it to your exams. This material must be bound as loose pages are not allowed in the test center.

Do not mark within any book or documents during an exam. If a candidate is observed or found to have marked in a book during an exam, or otherwise cheating, books may be confiscated by the proctoring center. Confiscated books may be sent to CSA for review. Video recordings of exams may also be reviewed. If it is concluded that a candidate has cheated, such books may be destroyed by CSA. The candidate will be out the cost of such books and may be prevented from taking future CSA exams. Additional criteria is outlined in the CSA Terms and Conditions.



TECHNICAL DATA

FREEDOM® RESIDENTIAL PENDENT SPRINKLER VK470 (K3.0)

The Viking Corporation, 210 N Industrial Park Drive, Hastings MI 49058

Telephone: 269-945-9501 Technical Services: 877-384-5464 Fax: 269-818-1680 Email: techsvcs@vikingcorp.com

1. DESCRIPTION

Viking Freedom® Residential Pendent Sprinkler VK470 is a thermosensitive, glass-bulb residential sprinkler available in several different finishes and temperature ratings to meet varying design requirements. The Electroless Nickel PTFE (ENT) coating has been investigated for installation in corrosive atmospheres and is C-UL-US-EU Listed as corrosion resistant as indicated in the Approval Chart. The sprinkler orifice design, with a K-Factor of 3.0 (43.2 metric*), allows efficient use of available water supplies for the hydraulically designed fire-protection system. The glass bulb operating element and special deflector characteristics meet the challenges of residential sprinkler standards.

2. LISTINGS AND APPROVALS



UL Listed (C-UL-US-EU): Category VKKW

Refer to the Approval Chart and Design Criteria for C-UL-US-EU Listing requirements that must be followed.

3. TECHNICAL DATA

Specifications:

Available since 2012.

Minimum Operating Pressure: Refer to the Approval Chart.

Maximum Working Pressure: 175 psi (12 bar). Factory tested hydrostatically to 500 psi (34.5 bar).

Thread size: 1/2" (15 mm) NPT

Nominal K-Factor: 3.0 U.S. (43.2 metric*)

* Metric K-factor measurement shown is in Bar. When pressure is measured in kPa, divide the metric K-factor shown by 10.0.

Glass-bulb fluid temperature rated to -65 °F (-55 °C)

Overall Length: 2-1/4" (58 mm)

Covered by the following U.S. Patent: 9,265,981

Material Standards:

Frame Casting: QM Brass

Deflector: Phosphor Bronze UNS-C51000 or Brass UNS-C23000

Bulb: Glass, nominal 3 mm diameter

Belleville Spring Sealing Assembly: Nickel Alloy, coated on both sides with PTFE Tape

Compression Screw: Brass UNS-C36000

Pip Cap and Insert Assembly: Copper UNS-C11000 and Stainless Steel UNS-S30400

For ENT coated sprinklers: Belleville spring - Exposed, Screw and Pipcap - ENT plated.

Ordering Information: (Also refer to the current Viking price list.)

Sprinkler: Base Part No. 17147

Order Sprinkler VK470 by first adding the appropriate suffix for the sprinkler finish and then the appropriate suffix for the temperature rating to the sprinkler base part number.

Finish Suffix: Brass = A, Chrome = F, White Polyester = M-/W, Black Polyester = M-/B, and ENT = JN

Temperature Suffix: 155 °F (68 °C) = B, 175 °F (79 °C) = D

For example, sprinkler VK470 with a Brass finish and a 155 °F (68 °C) temperature rating = Part No. 17147AB.

Available Finishes And Temperature Ratings: Refer to Table 1.

Accessories: (Also refer to the Viking website)

Sprinkler Wrenches:

A. Standard Wrench: Part No. 10896W/B (available since 2000)

B. Wrench for Recessed Sprinklers: Part No. 13655W/B** (available since 2006)

C. Optional Protective Sprinkler Cap Remover/Escutcheon Installer Tool*** Part No. 15915 (available since 2010.)

**A 1/2" ratchet is required (not available from Viking).

***Allows use from the floor by attaching a length of 1" diameter CPVC tubing to the tool. Ideal for sprinkler cabinets. Refer to Bulletin F_051808.

Sprinkler Cabinets:

A. Six-head capacity: Part No. 01724A (available since 1971)

B. Twelve-head capacity: Part No. 01725A (available since 1971)



Viking Technical Data may be found on
The Viking Corporation's Web site at
<http://www.vikinggroupinc.com>.

The Web site may include a more recent
edition of this Technical Data Page.



TECHNICAL DATA

FREEDOM® RESIDENTIAL PENDENT SPRINKLER VK470 (K3.0)

The Viking Corporation, 210 N Industrial Park Drive, Hastings MI 49058

Telephone: 269-945-9501 Technical Services: 877-384-5464 Fax: 269-818-1680 Email: techsvcs@vikingcorp.com

4. INSTALLATION

Refer to appropriate NFPA Installation Standards.

5. OPERATION

During fire conditions, the heat-sensitive liquid in the glass bulb expands, causing the glass to shatter, releasing the pip cap and sealing spring assembly. Water flowing through the sprinkler orifice strikes the sprinkler deflector, forming a uniform spray pattern to extinguish or control the fire.

6. INSPECTIONS, TESTS AND MAINTENANCE

Refer to NFPA 25 for Inspection, Testing and Maintenance requirements.

7. AVAILABILITY

The Viking Model VK470 Sprinkler is available through a network of domestic and international distributors. See The Viking Corporation web site for the closest distributor or contact The Viking Corporation.

8. GUARANTEE

For details of warranty, refer to Viking's current list price schedule or contact Viking directly.

TABLE 1: AVAILABLE SPRINKLER TEMPERATURE RATINGS AND FINISHES

Sprinkler Temperature Classification	Sprinkler Nominal Temperature Rating ¹	Maximum Ambient Ceiling Temperature ²	Bulb Color
Ordinary	155 °F (68 °C)	100 °F (38 °C)	Red
Intermediate	175 °F (79 °C)	150 °F (65 °C)	Yellow

Sprinkler Finishes: Brass, Chrome, White Polyester, Black Polyester, and ENT

Corrosion Resistant Coatings³: ENT

Footnotes

¹ The sprinkler temperature rating is stamped on the deflector.

² Based on NFPA-13. Other limits may apply, depending on fire loading, sprinkler location, and other requirements of the Authority Having Jurisdiction. Refer to specific installation standards.

³ The corrosion resistant coatings have passed the standard corrosion test required by the approving agencies indicated in the Approval Chart. These tests cannot and do not represent all possible corrosive environments. Prior to installation, verify through the end-user that the coatings are compatible with or suitable for the proposed environment. For ENT coated sprinklers, the waterway is coated. Note that the spring is exposed on sprinklers with ENT coating.

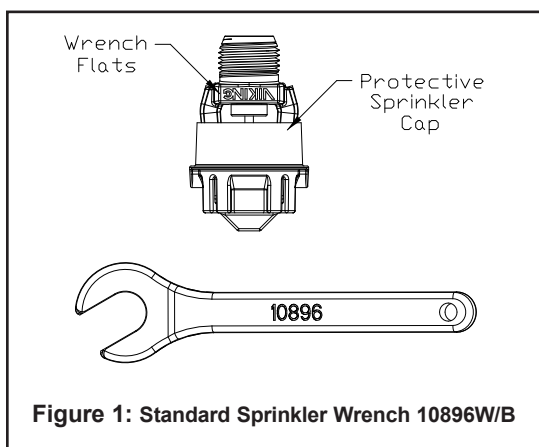

Figure 1: Standard Sprinkler Wrench 10896W/B



TECHNICAL DATA

FREEDOM® RESIDENTIAL PENDENT SPRINKLER VK470 (K3.0)

The Viking Corporation, 210 N Industrial Park Drive, Hastings MI 49058

Telephone: 269-945-9501 Technical Services: 877-384-5464 Fax: 269-818-1680 Email: techsvcs@vikingcorp.com

Approval Chart Viking VK470, 3.0 K-Factor Residential Pendent Sprinkler

For systems designed to NFPA 13D or NFPA 13R. For systems designed to NFPA 13, refer to the design criteria. For Ceiling types refer to the current editions of NFPA 13, 13R or 13D

Sprinkler Base Part Number ¹	SIN	NPT Thread Size		Nominal K-Factor		Maximum Water Working Pressure	Overall Length			
		Inches	mm	U.S.	metric ²		Inches	mm		
17147	VK470	1/2	15	3.0	43.2	175 psi (12 bar)	2-1/4	58		
Max. Coverage Area ⁴ Ft.X Ft. (m X m)	Ordinary Temp Rating (155 °F/68 °C)		Intermediate Temp Rating (175 °F/79 °C)		Deflector to Ceiling	Installation Type	Listings and Approvals ³			Minimum Spacing Ft. (m)
	Flow ⁴ GPM (L/min)	Pressure ⁴ PSI (bar)	Flow ⁴ GPM (L/min)	Pressure ⁴ PSI (bar)			 ⁵	NYC	NSF	
12 X 12 (3.7 X 3.7)	8 (30.3)	7.11 (0.49)	8 (30.3)	7.11 (0.49)	1-1/8 to 2 inch	Standard surface-mounted escutcheons, the Microfast® Model F-1 Adjustable Escutcheon, or recessed with the Micromatic® Model E-1, E-2, or E-3 Recessed Escutcheon	See Footnotes 6 and 9	See Footnote 7	--	8 (2.4)
14 X 14 (4.3 X 4.3)	10 (37.9)	11.11 (0.77)	10 (37.9)	11.11 (0.77)						
16 X 16 (4.9 X 4.9)	13 (49.2)	18.8 (1.29)	13 (49.2)	18.8 (1.29)						

Footnotes

¹ Part number shown is the base part number. For complete part number, refer to Viking's current price schedule.

² Metric K-factor measurement shown is when pressure is measured in Bar. When pressure is measured in kPa, divide the metric K-factor shown by 10.0.

³ This chart shows the listings and approvals available at the time of printing. Other approvals may be in process. Check with the manufacturer for any additional approvals. Refer also to Design Criteria.

⁴ For areas of coverage smaller than shown, use the "Flow" and "Pressure" for the next larger area listed. Flows and pressures listed are per sprinkler.

⁵ Listed by Underwriter's Laboratories, Inc. for use in the U.S., Canada, and European Union.

⁶ Approved Finishes are: Brass, Chrome, White Polyester, and Black Polyester ⁸.

⁷ Meets New York City requirements, effective July 1, 2008.

⁸ Other paint colors are available on request with the same C-UL-US-EU listings as the standard finish colors.

⁹ Approved finish is Electroless Nickel PTFE (ENT). ENT is C-UL-US-EU Listed as corrosion resistant. ENT is available with standard surface-mounted escutcheons or the Micromatic Model E-1 Recessed Escutcheon.



TECHNICAL DATA

**FREEDOM® RESIDENTIAL
PENDENT SPRINKLER
VK470 (K3.0)**

The Viking Corporation, 210 N Industrial Park Drive, Hastings MI 49058

Telephone: 269-945-9501 Technical Services: 877-384-5464 Fax: 269-818-1680 Email: techsvcs@vikingcorp.com

DESIGN CRITERIA

(Also refer to the Approval Chart.)

UL Listing Requirements (C-UL-US-EU):

When using Viking Residential Pendent Sprinkler VK470 for systems designed to NFPA 13D or NFPA 13R, apply the listed areas of coverage and minimum water supply requirements shown in the Approval Chart.

For systems designed to NFPA 13: The number of design sprinklers is to be the four contiguous most hydraulically demanding sprinklers. The minimum required discharge from each of the four sprinklers is to be the greater of the following:

- The flow rates given in the Approval Chart for NFPA 13D and NFPA13R applications for each listed area of coverage, **or**
- Calculated based on a minimum discharge of 0.1 gpm/sq. ft. over the “design area” in accordance with sections 8.5.2.1 or 8.6.2.1.2 of NFPA 13.
- Minimum distance between residential sprinklers: 8 ft. (2.4 m).

IMPORTANT: Always refer to Bulletin Form No. F_091699 - Care and Handling of Sprinklers. Also refer to Form No. F_080614 for general care, installation, and maintenance information. Viking sprinklers are to be installed in accordance with the latest edition of Viking technical data, the appropriate standards of NFPA and any other similar Authorities Having Jurisdiction, and also with the provisions of governmental codes, ordinances, and standards, whenever applicable. Final approval and acceptance of all residential sprinkler installations must be obtained from the Authorities Having Jurisdiction.

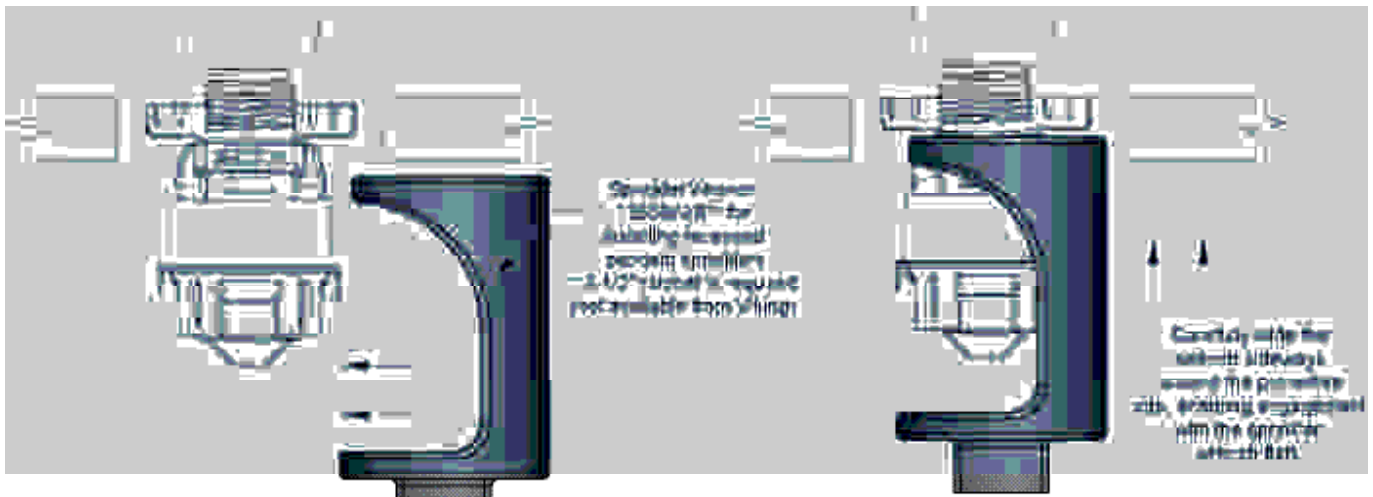

Figure 2: Wrench 13655W/B for Installing Recessed Sprinkler VK470

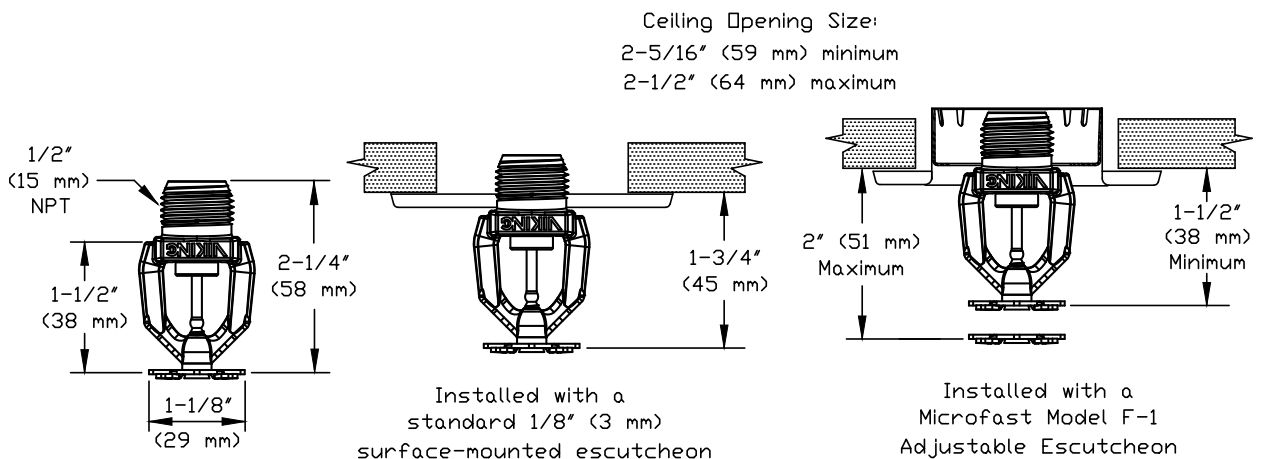

Figure 3: Sprinkler VK470 Dimensions with a Standard Escutcheon and the Model F-1 Adjustable Escutcheon



TECHNICAL DATA

FREEDOM® RESIDENTIAL
PENDENT SPRINKLER
VK470 (K3.0)

The Viking Corporation, 210 N Industrial Park Drive, Hastings MI 49058

Telephone: 269-945-9501 Technical Services: 877-384-5464 Fax: 269-818-1680 Email: techsvcs@vikingcorp.com

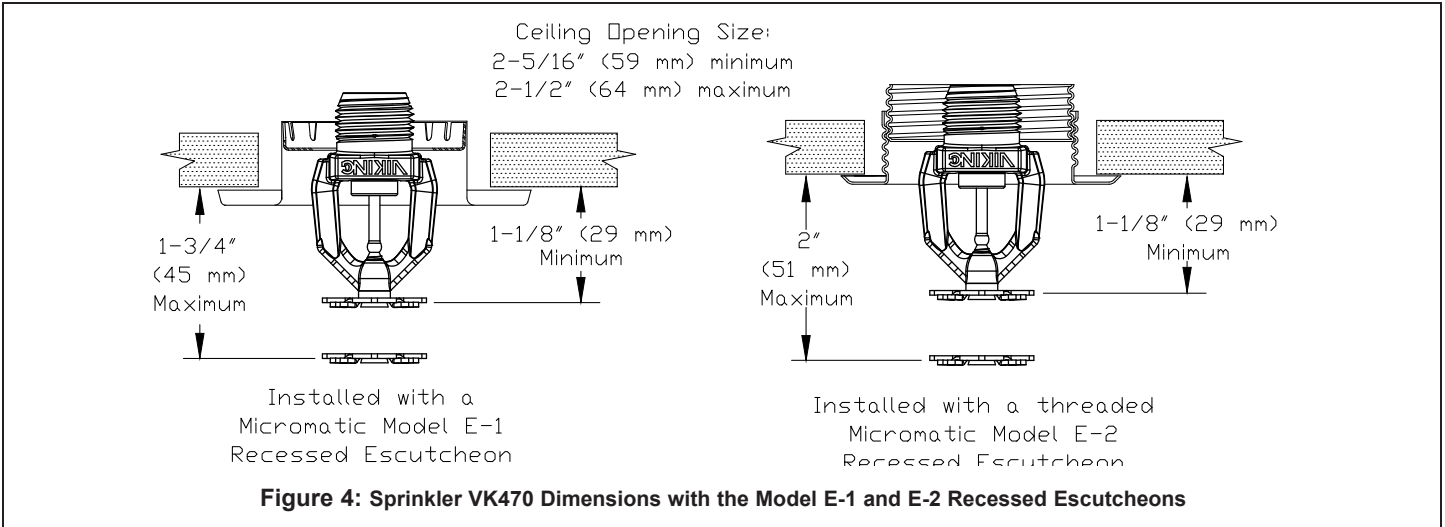

Reliable®

Model RFS42 Residential Flat Concealed Horizontal Sidewall Sprinkler (SIN RA4835)

Coverage to 16 ft. x 20 ft. (4.9m x 6.1m)

Features:

1. Flat cover plate (Solid or Perforated) for a flush, concealed wall finish.
2. 4.2 (60 metric) K Factor.
3. Sized to fit in a 3½" or larger stud space even when installed directly in a TorqueSafe™ 90° Sprinkler Head Elbow** and several other common ½" and ¾" by ½" sprinkler fittings.
4. Push-on/pull-off flat cover plate.
5. Sprinkler shipped complete with factory installed protective cap.
6. Sprinkler assembly and cover plate packaged separately.
7. 1/8" (3.2 mm) cover plate adjustment.
8. Cover plate available, either solid or perforated, in a wide variety of colors and finishes.

Listings & Approvals

1. Listed by Underwriters Laboratories Inc. and UL certified for Canada (cULus).

UL Listing Category

Residential Automatic Sprinklers

UL Guide Number

VKKW

Patents:

U.S. Patent No. 7,353,882, other Patents pending

Product Description

The Reliable Model RFS42 Concealed Residential Extended Coverage Horizontal Sidewall Sprinkler is an attractive, concealed sprinkler assembly specially sized to fit within a 3½" or larger stud space. The sprinkler uses a push-on/pull-off flat cover plate assembly. The sprinkler assembly is shipped with a protective cap.

The flat cover plate is attached to the skirt using 135°F (57°C) ordinary temperature classification solder. The sprinkler is installed into the sprinkler fitting using the Model G6 Sprinkler Wrench.

When the ambient temperature rises, the solder holding the cover plate melts, allowing the release of this part and thus exposing the sprinkler inside to the rising ambient temperature.

This sprinkler is listed for a maximum service pressure of 175 psi (12,0 bar).



Application and Installation

The Model RFS42 sprinkler is intended for installation in the residential portions of any occupancy in accordance with NFPA 13, 13R & 13D. The sprinkler is listed as a Concealed Residential Horizontal Sidewall Sprinkler using a smooth, flat, horizontal ceiling. System design and installation requirements for other ceiling configurations are described in NFPA 13, 13R or 13D, as applicable.

The minimum listed spacing between Model RFS42 sprinklers is 8 ft (2.4 m).

The low flow RFS42RES sprinklers are specifically engineered to meet the latest residential sprinkler listing standards (UL 1626 Standard).*

The sprinkler must be installed and properly oriented with the Model G6 Wrench, as follows:

Do not remove the factory installed plastic protective cap since it is sized to fit inside the G6 wrench. Note that the sprinkler can only mate when the sprinkler's deflector orientation tab (Fig. 1) is aligned with wrench's key-way. The G6 wrench is provided with bubble level pad and TOP marking, to allow the proper orientation of the horizontal sidewall deflector. Final leveling can be done after leak proof joint is obtained with a minimum to maximum torque of 8 to 18 ft-lbs (11 to 24 N·m). Leave the protective cap on to protect the sprinkler while the wall is plastered, wallpapered or painted. The protective cap must be removed and the listed cover plate installed prior to the sprinkler system being placed in service. A 2⁵/₈" (67 mm) diameter hole must be cut in the wall for the sprinkler assembly to extend through.

Concealed cover plate/cup assemblies are listed only for use with specific sprinklers. The use of any other concealed cover plate/cup assembly with the Model RFS42 Horizontal Sidewall Sprinkler or the use of this dedicated concealed cover plate assembly on any sprinkler with which it is not specifically listed will void all guarantees, warranties, listings and approvals.

* Effective date 3/14/2008

**Spears Manufacturing Company

Technical Data:

Orifice Size	"K" Factor		Thread Size	Maximum Ambient Temperature	Maximum Water Working Pressure	Sprinkler Identification Number (SIN)	Approvals
	US	Metric					
3/8" (9.6mm)	4.2	60	1/2" NPT (R1/2)	100°F (38°C)	175 PSI (12 bar)	RA4835	cULus

Listed Design Criteria***									
Max. Coverage Area Width x Length		Deflector to Ceiling Dimension		Flow Rate		Pressure		Temperature Rating	
ft. x ft.	m x m	inches	mm	gpm	L/min	psi	bar	Sprinkler	Cover
12 x 12	3.6 x 3.6	4 - 6	102 - 152	12	45.4	8.2	0.57	165°F (74°C)	135°F (57°C)
12 x 12	3.6 x 3.6	6 - 12	152 - 305	13	49.2	9.6	0.67		
14 x 14	4.3 x 4.3	4 - 6	102 - 152	12	45.4	8.2	0.57		
14 x 14	4.3 x 4.3	6 - 12	152 - 305	14	53.0	11.1	0.78		
16 x 16	4.9 x 4.9	4 - 12	102 - 305	16	60.6	14.5	1.01		
16 x 18	4.9 x 5.5	4 - 12	102 - 305	18	68.1	18.4	1.29		
16 x 20	4.9 x 6.1	4 - 6	102 - 152	22	83.3	27.4	1.92		
16 x 20	4.9 x 6.1	6 - 12	152 - 305	23	87.0	30.0	2.10		

***For NFPA 13 systems calculate for a minimum design density of 0.1 gpm/sf, but in no case go below the Listed Design Criteria Flow Rate and Pressure.

Material Data

Bronze	Sprinkler Body, Spring Closure Cap, Yoke, Lever, Slide Pin, Slide Plate, Deflector, Set Screw
Brass	Cover Plate, Sprinkler Sleeve, Frame Arms
Stainless Steel	Push Spring, Ball, Load Screw, Rivet
Copper Plated Steel	Cover Plate Skirt
Nickel Alloy	Fusible Element
Nickel Alloy coated with PTFE Adhesive Tape	Sealing Washer

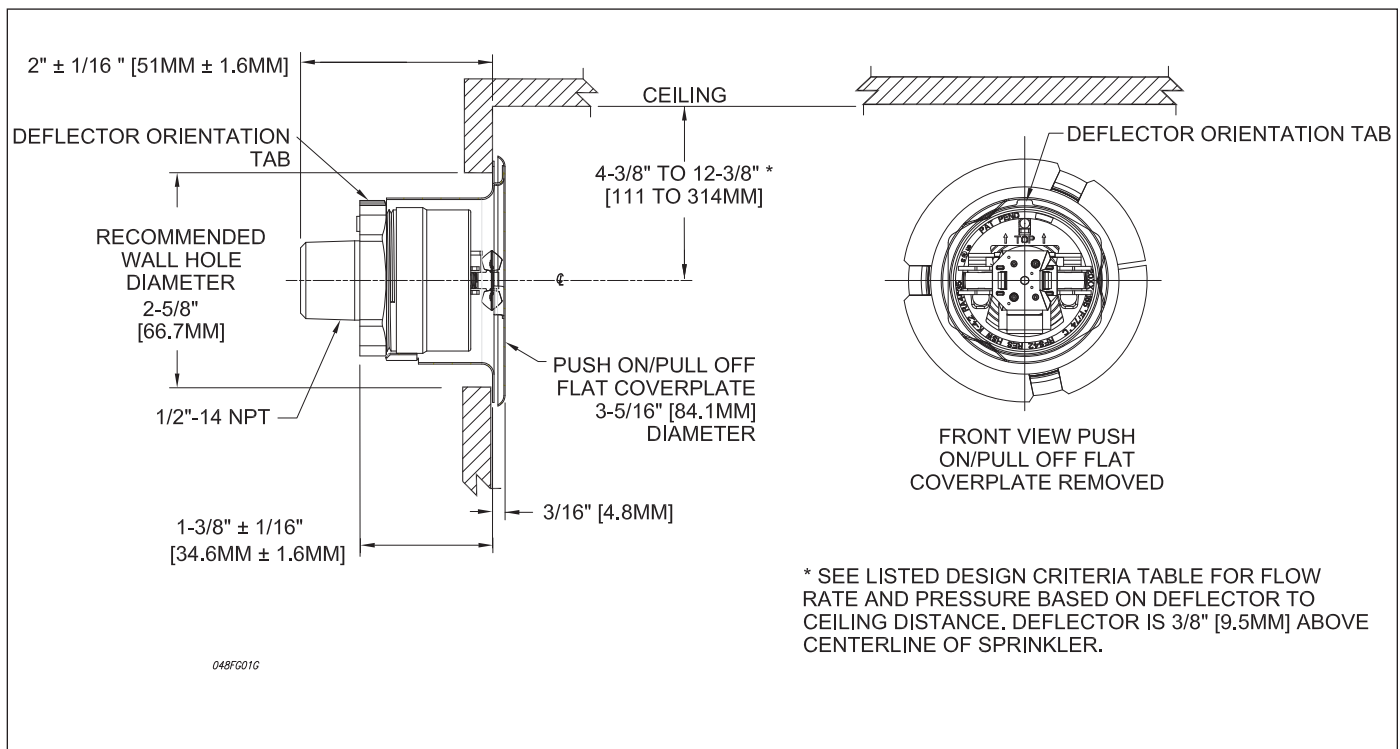

Fig. 1

Installation Guide for 3½" or Larger Stud Space

RFS42 Residential Flat Cover Concealed Horizontal Sidewall Sprinkler SIN RA4835

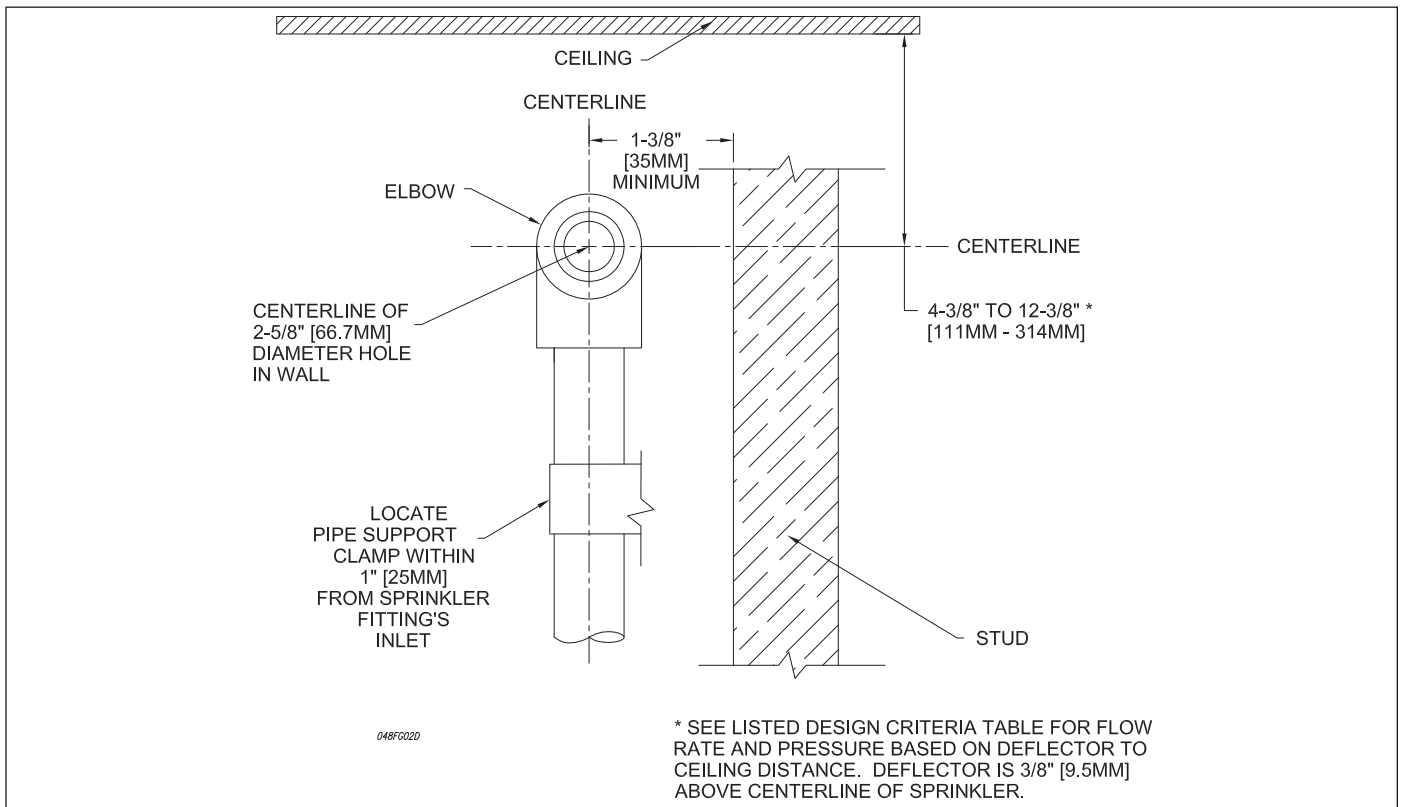

Fig. 2
Front View

Attachment Method:

Fig. 3:

1. Securely support pipe from adjacent stud.
2. Pipe support clamp shall be located within 1" [25 mm] of sprinkler fitting's inlet lip.
3. The center of the sprinkler fitting shall be located at a horizontal distance of 1⅜" [35 mm] or more from the stud (Fig. 3).
4. The sprinkler fitting shall be installed so that the rear of the sprinkler is 2" +/- 1/16" from the finished surface of the wall. Verify wall assembly dimensions prior to installation to ensure that the cover plate attaches to the sprinkler and seats against the finished wall surface (Fig. 1).

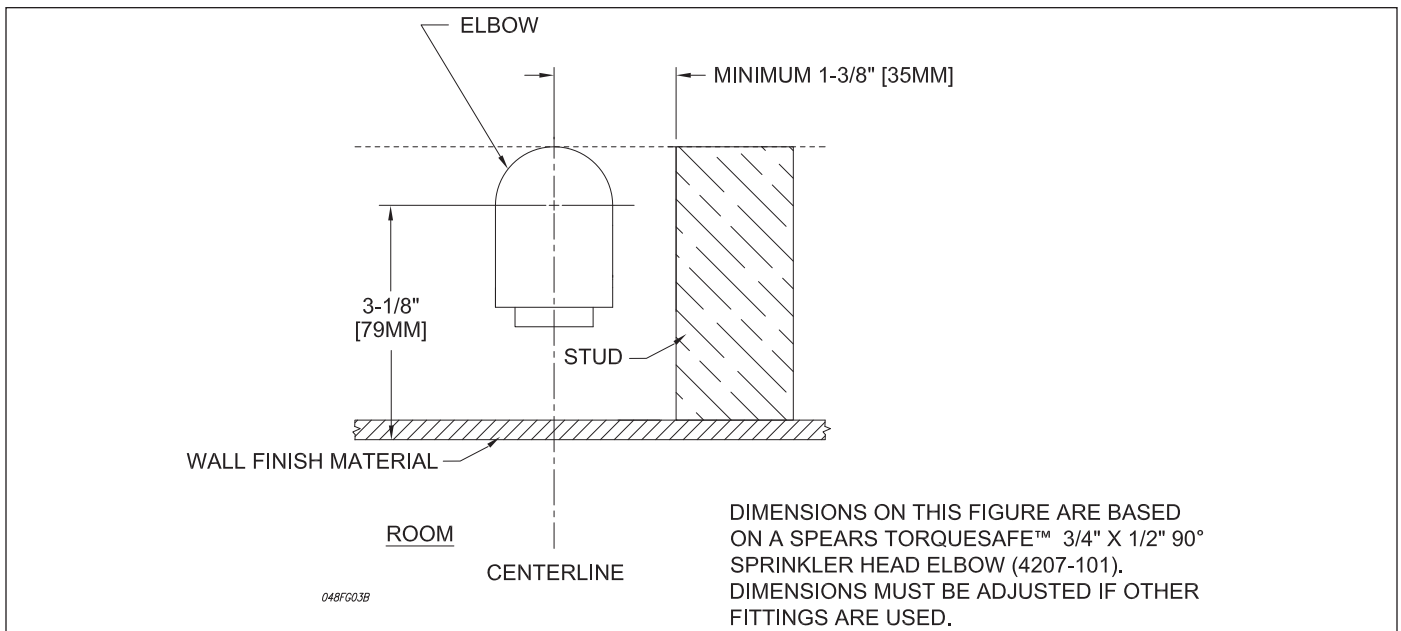

Fig. 3

5. Maintenance

Model RFS42 Concealed Sprinklers should be inspected and maintained in accordance with NFPA 25. Do not clean sprinklers with soap and water, ammonia or any other cleaning fluids. Remove dust by using a soft brush or gentle vacuuming. Replace any sprinkler or cover plate assembly, which has been painted (other than factory applied) or damaged in any way. A stock of spare sprinklers should be maintained to allow quick replacement of damaged or operated sprinklers. Prior to installation, sprinklers should be maintained in their original cartons and packaging until used to minimize the potential for damage to sprinklers that would cause improper operation or non-operation. Once operated automatic sprinklers and cover plates cannot be reassembled and reused. New sprinklers of the same size, type and temperature rating must be installed. A cabinet of replacement sprinklers should be provided for this purpose.

Model RFS42 Residential Flat Cover Concealed Horizontal Sidewall Sprinkler Specification

Sprinklers shall be a UL listed as residential flat cover concealed horizontal sprinkler with RFS42 deflector and adjustable cover plate for light hazard, interior, non-corrosive applications. Sprinklers to be of bronze frame construction with brass cover plate and copper alloy retainer flange assembly. Water seal assembly shall consist of a Teflon* coated Belleville spring washer and machined brass cup containing no plastic parts. Method of attaching the cover plate to the sprinkler cup shall be a Push-on and Pull-off design allowing a 1/8" cover plate adjustment. Sprinklers shall have a nominal K-factor of 4.2 (60 metric), and 1/2" NPT thread. Sprinkler temperature rating shall be 165°F (74°C) with a cover plate temperature rating of 135°F (57°C). Sprinklers shall be capable of a maximum coverage area of 16 ft. x 20 ft. (4.9 m x 6.1 m), with a minimum lateral spacing of 8 ft. (2.4 m). Rated working pressure shall be 175 psi (12.0 bar). A plastic protective cap shall be provided and factory installed onto the sprinkler cup to protect the sprinkler from damage, which could occur during construction before the cover plate is installed. Cover plate type: [Solid] [Perforated]. Cover plate finish: [White] [Custom Color-specify]. Residential Coverage Concealed horizontal sidewall sprinklers shall be Reliable Model RFS42. SIN RA4835 (Bulletin 048).

*DuPont Registered Trademark

Cover Plate Finishes⁽¹⁾

Standard Finish
White
Special Application Finishes
Flat White Paint
Off White Paint
Black Paint
Custom Color Paint
Bright Brass
Bronze
Chrome
Satin Chrome
Black Plating

⁽¹⁾ Other colors and finishes are available. Consult factory for details.

Note: Paint or any other coatings applied over the factory finish will void all approvals and warranties.

Ordering Information

Specify:

1. Model RFS42 Residential Sidewall
2. Cover Plate Type: Solid or Perforated
3. Cover Plate Finish

Installation Wrench

Model G6 Sprinkler Wrench

Installation Aid

A protective plastic cap is included for use during installation.

The equipment presented in this bulletin is to be installed in accordance with the latest published Standards of the National Fire Protection Association, Factory Mutual Research Corporation, or other similar organizations and also with the provisions of governmental codes or ordinances whenever applicable. Products manufactured and distributed by Reliable have been protecting life and property for over 90 years, and are installed and serviced by the most highly qualified and reputable sprinkler contractors located throughout the United States, Canada and foreign countries.

Manufactured by

Reliable[®]

Reliable Automatic Sprinkler Co., Inc.

(800) 431-1588

(800) 848-6051

(914) 829-2042

www.reliablesprinkler.com

Sales Offices

Sales Fax

Corporate Offices

Internet Address



Recycled
Paper

Revision lines indicate updated or new data.

EG. Printed in U.S.A. 04/15 P/N 9999970457



CPVC
Fire Sprinkler Products
INSTALLATION
INSTRUCTIONS



Visit our website:
www.spearsmfg.com

FlameGuard® LIMITED LIFETIME WARRANTY

Except as otherwise mandated by law or herein provided, Spears® Manufacturing Company ("Company") warrants Standard Catalog Products ("Products") which have been directly manufactured by them to be free from defects in material and workmanship for as long as the original intended end user of the Products ("End User") retains ownership and possession of the Products and complies with this Warranty ("Warranty Period"). Products installed with pipe, fittings, valves, solvent cements, threads sealants or other related products, not manufactured by this company, are subject to review and may be exempt at the sole discretion of the Company. Each other person or entity acquiring or employing the Products, including buyers, contractors and installers ("Buyer") and End Users ("Buyer/End User") agrees that this Warranty shall be effective only during the Warranty Period so long as the Products are used solely for the normal purposes for which they are intended and in conformance with industry established standards, engineering, installation, operating, and maintenance specifications, recommendations and instructions including explicit instructions by the Company; the Products are properly installed, operated and used, and have not been modified; and all the other terms of this Warranty are complied with. Any violation thereof shall void this Warranty and relieve Company from all obligations arising from this Warranty and the Products.

Upon receipt or discovery of any Products that appear questionable or defective each Buyer/End User shall promptly inspect and return any such Product to the Company at 15853 Olden Street, Sylmar, California 91342, accompanied by a letter stating the nature of any problems. If the Products are determined by Company to be defective in materials or workmanship directly provided by Company, Company, at its sole option, may either repair or replace the defective Products, or reimburse applicable Buyer/End User for the cost of such Products. The applicable Buyer/End User shall bear all applicable shipping costs. THIS SHALL BE BUYERS/END USERS' SOLE REMEDY. EACH BUYER/END USER AGREES THAT COMPANY WILL NOT BE RESPONSIBLE FOR ANY OTHER OBLIGATIONS RELATING TO THE PRODUCTS, INCLUDING ANY OTHER MATERIALS OR LABOR COSTS, LOSS OF USE OR ANY OTHER ITEM OR FOR ANY DELAYS IN COMPLYING WITH THIS WARRANTY BEYOND COMPANY'S REASONABLE CONTROL.

COMPANY SHALL NOT BE LIABLE FOR, DOES NOT ASSUME, AND EXPRESSLY DISCLAIMS, ANY LIABILITY, RESPONSIBILITY AND DAMAGES: DUE TO ANY BUYER/END USER'S FAILURE TO COMPLY WITH THIS WARRANTY, INCLUDING IMPROPER INSTALLATION, USE OR OPERATION; USE WITH PRODUCTS FROM OTHER MANUFACTURERS THAT DO NOT MEET ASTM OR OTHER APPLICABLE PRODUCT STANDARDS; IMPROPER CONTROL OF SYSTEM HYDRAULICS, IMPROPER WINTERIZATION PROCEDURES, IMPROPER VOLTAGE SUPPLY, CONTACT WITH INCOMPATIBLE MATERIALS OR CHEMICALS, EXCAVATION/DIGGING, EXCESSIVE WEIGHT, AND VANDALISM; DUE TO REASONABLE WEAR AND TEAR AND DUE TO ANY ACTS OF NATURE, INCLUDING LIGHTNING, EARTHQUAKES, GROUND MOVEMENT, FROST HEAVE, OR FLOODS.

COMPANY EXTENDS ONLY THIS WARRANTY AND EXPLICITLY DISCLAIMS ALL OTHER WARRANTIES, WHETHER IMPLIED OR OTHERWISE EXPRESSED, WHETHER ORAL, STATUTORY OR OTHERWISE, INCLUDING ANY IMPLIED WARRANTIES OR AFFIRMATIONS FOR SUITABILITY, MERCHANTABILITY OR FITNESS FOR A PARTICULAR PURPOSE. NO AFFIRMATION BY COMPANY OR ANY OF ITS REPRESENTATIVES, BY WORDS, CONDUCT OR OTHERWISE, SHALL CONSTITUTE A WARRANTY. THIS WARRANTY MAY NOT BE TRANSFERRED, EXTENDED, ALTERED OR OTHERWISE MODIFIED IN ANY MANNER, EXCEPT BY WRITTEN AGREEMENT SIGNED BY COMPANY.

BY ITS ACCEPTANCE OF THE PRODUCTS, EACH BUYER/END USER EXPRESSLY WAIVES ALL OTHER LIABILITY OR OBLIGATION OF ANY KIND OR CHARACTER OF COMPANY, INCLUDING LIABILITY PREDICATED UPON CONTRACT, TORT, STRICT LIABILITY OR OTHER LEGAL OR EQUITABLE GROUNDS, AND ALL, IF ANY, DAMAGES AND LOSSES AS A RESULT THEREOF, INCLUDING ALL, IF ANY, COMPENSATORY, GENERAL, SPECIAL, CONSEQUENTIAL, INCIDENTAL, OR PUNITIVE DAMAGES. WITH RESPECT TO SUCH WAIVERS, EACH BUYER/END USER EXPLICITLY WAIVES CALIFORNIA CIVIL CODE §1542 WHICH STATES "A GENERAL RELEASE DOES NOT EXTEND TO CLAIMS WHICH THE CREDITOR DOES NOT KNOW OR SUSPECT TO EXIST IN HIS FAVOR AT THE TIME OF EXECUTING THIS RELEASE, WHICH IF KNOWN BY HIM MUST HAVE MATERIALLY ADVERSELY AFFECTED HIS SETTLEMENT WITH DEBTOR" AND ALL OTHER SIMILAR STATUTORY, COMMON AND CASE LAW RIGHTS, DEFENSES AND LIMITATIONS.

Having previously independently inspected the Products, or a sample, as fully as desired, or having the opportunity to and having not done so, upon acceptance of delivery of the Products, and except as otherwise herein explicitly provided, each Buyer/End User by acceptance or use of the Products accepts them in their "AS IS" and "WITH ALL FAULTS" condition without any other warranty, expressed, implied or otherwise, and accepts and assumes the entire risk and cost of all servicing, remediation and consequences thereof. This Warranty shall be governed by California law and any unenforceable provisions severed without affecting the remaining provisions. As used herein, "including" includes "without limitation."

TABLE OF CONTENTS

Warranty _____	Inside Cover
IMPORTANT INFORMATION _____	4
Use of this Manual • Hazards & Information Definitions _____	4
System Engineering, Installation & Maintenance _____	4
Installer Training _____	5
General Installation Safety Instructions _____	5
Introduction _____	5
Handling & Storage _____	6
Pipe & Fittings _____	6
One-Step Solvent Cement _____	6
Listing, Approvals, Application & Use _____	7
Light Hazard Occupancies _____	7
Residential Occupancies _____	8
Low Pressure Dry Pipe and Pre-action Systems _____	8
Concealed Installations _____	9
Combustible Concealed Installation with Specific Use Sprinklers _____	10
Combustible Attic Spaces with Specific Use Sprinklers _____	10
Exposed Installations _____	10
Expanded Use with Light Hazard Extended Coverage and Residential Sprinklers _____	11
Unfinished Basement with Exposed Solid Wood Joist Installation _____	12
Extended Coverage Quick Response Sprinklers _____	16
Return Air Plenum Installation • Garage Installations _____	17
Ambient Temperature Limitations • High Temperature Areas _____	17
Cold Temperature Areas _____	18
Fire Sprinkler System Risers _____	19
Underground Fire Service • C-UL Listing Requirements _____	20-21
Factory Mutual Approvals _____	22
Loss Prevention Certification Board LPCB _____	22-23
NSF International _____	23
Penetrating Fire-related Walls & Partitions _____	23
Heat Sources & Open Ceiling Areas _____	23
Use With Other Manufacturers' Pipes, Fittings & Solvent Cement _____	24
Installation & Joining _____	24
Solvent Cement Welded Joints _____	24
Solvent Cement Requirements _____	29
Threaded Connections _____	29-30
TorqueSafe™, QuickTorque™ & SofTorque™ Gasket Sealed Thread Connections _____	31-32
GripLoc™ Fitting Connections _____	33
Painting Pipe & Fittings • Cleaning _____	34
Transition to Other Materials • Flanged Connections _____	34
Flange Data & Bolt Torque • Grooved Coupling Adapters _____	35-36
Adjustable Sprinkler Head Adapter Installation _____	37
Flushing System _____	38
System Acceptance Testing (Hydrostatic Pressure Test) _____	39
Recommended Cut-in Procedures for Systems Modification or Repair _____	39
Engineering Data _____	41
Pipe & Fitting Specifications • Hydraulic Design _____	42
Allowance for Friction Loss in Fittings _____	42
Hanger & Supports _____	43
Riser Support _____	46
Exposed Installations • Earthquake Bracing • Trenching _____	47
Snaking/Deflection of Pipe _____	48
Backfilling _____	49
Material Properties _____	50
Expansion & Contraction _____	51
Expansion Loop & Offset Configurations _____	52-54
Review - Do's & Don'ts _____	56-57
Material Safety Data Sheet _____	58-65

IMPORTANT INFORMATION

Please Read the Following Section Before Proceeding

Use of this Manual

Spears® FlameGuard® CPVC Fire Sprinkler Products are approved for use in combination with other listed manufacturers' products (see, "Use With Other Manufacturers' Pipes, Fittings, and Solvent Cements" section). However, specific application approvals may not be the same amongst manufacturers. **It is the installer's responsibility to verify suitability of products used in combination according to each manufacturer's installation instructions.** Engineering data related to the installation and use of CPVC Fire Sprinkler Pipe provided in this manual is based on product manufactured by Spears® Manufacturing Co. (Spears® FlameGuard®). If products other than Spears® are used, follow the appropriate manufacturer's installation instructions. Contact Spears® if questions on any application are not addressed in this manual.

This manual is intended for use by specifiers, installers, and users in the selection, design, installation, and inspection of Spears® FlameGuard® CPVC Fire Sprinkler Products for fire protection service. Due to the critical safety and loss prevention uses of such systems, all information contained herein is considered vital to obtain proper system performance and **must be read and understood carefully before starting the installation.** The information contained within this manual is accurate at the time of publication to the best of our knowledge. It is not meant as a replacement for formal installer training. We do not make any guarantees nor assume any liabilities arising out of its use. If you need additional copies, or if you have any questions about the safe installation and use of these products, contact Spears® Manufacturing Company, P.O. Box 9203, Sylmar, CA 91392 or call (800) 862-1499. Additional copies of this manual may be downloaded from our web site: www.spearsmfg.com.

Hazards & Information Definitions

Definitions for identifying the various hazard levels are as follows:

- **WARNING** - The use of the word "WARNING" identifies the presence of hazards or unsafe practices that could result in severe personal injury if instructions, including recommended precautions, are not followed.
- **CAUTION** - The use of the word "CAUTION" identifies possible hazards or unsafe practices that could result in personal injury, product damage, and/or property damage if instructions, including precautions, are not followed.
- **NOTICE** - The use of the word "NOTICE" identifies special instructions that are highly important but not related to hazards.
- Text information in bold print – **Text in bold print identifies additional important information that may or may not be related to a hazard, according to the topic and context.**

System Engineering, Installation & Maintenance

CPVC Fire Sprinkler Systems must be engineered, installed and maintained in accordance with local codes, standards and Spears® FlameGuard® CPVC Fire Sprinkler Products Installation Instructions. Code requirements and field conditions may differ. It is the responsibility of the installing contractor to ensure that the product is suitable for the intended use and that all requirements have been satisfied.

Installer Training

Spears® Manufacturing Company recommends that installers receive proper installation training and that training be renewed every two (2) years. Training will be provided at no charge by contacting an authorized Spears® FlameGuard® CPVC Fire Sprinkler Products distributor or your nearest Spears® Regional Distribution Center.

General Installation Safety Instructions

- Use only recommended accessories. Use of improper accessories or unapproved system components in conjunction with Spears® FlameGuard® CPVC Fire Sprinkler Products will void the warranty and may result in improper operation of the system.
- **CAUTION:** Avoid dangerous environments. If utilizing electrically powered tools for installation, be sure that the area is free of moisture or wetness that could create an unsafe condition. Keep work area clean and well illuminated. Allow sufficient space for measuring and system dry-fit to accommodate proper installation.
- Prevent back injury. Always practice safe lifting and installation techniques.
- Use only tools specifically designed for plastic pipe and fittings.
- Inspect the products. Be sure that all parts are included and that you have all necessary tools available to properly install the system.

CAUTION: Follow all workplace safety requirements. Wear safety glasses, hardhat, and safety footwear. Always practice safety first.

- When solvent cementing, always work in a well-ventilated area. Avoid sources of heat or open flames. DO NOT smoke. Wear protective gloves. PVA-coated protective gloves are recommended for use while solvent cementing. If hands come in contact with solvent cement, use a waterless, abrasive soap.
- Wear ear protection. Protect your hearing if you are exposed to long periods of very noisy job-site operations.

INTRODUCTION

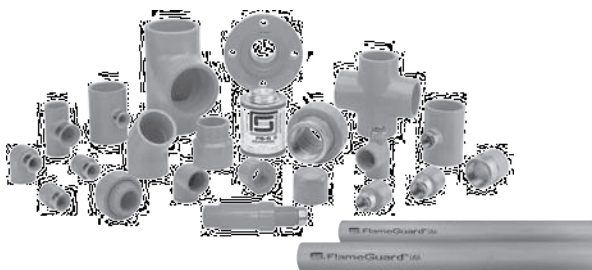

Spears® FlameGuard® CPVC Fire Sprinkler Products are manufactured from high quality, Post-Chlorinated Poly Vinyl Chloride (CPVC), a specialty thermoplastic material tested and approved by certifying agencies for use in CPVC fire sprinkler systems. Spears® FlameGuard® CPVC Fire Sprinkler Products provide unique advantages over traditional metal fire sprinkler systems through superior hydraulics, ease of installation and handling and quick assembly using readily available, inexpensive tools.

Handling & Storage

Pipes & Fittings

Spears® FlameGuard® CPVC Fire Sprinkler Products resist attack from a large group of chemicals that are corrosive to metallic piping. However, care must be taken to avoid contact with chemicals that are harmful to CPVC including those found in some common construction products. Specific chemicals or chemical vapors that contact CPVC can weaken or severely damage the system. Consult with the chemical manufacturer or Spears® before use.

WARNING: DO NOT expose Spears® FlameGuard® CPVC Fire Sprinkler Products to edible oils, esters, ketones, or petroleum-based products, such as cutting oils, packing oils, traditional pipe thread pastes or dopes, and some lubricants. Do not store or install CPVC products in direct contact with plasticizer containing materials such as electrical tape or certain wire and cable insulations. Consult with the chemical manufacturer for compatibility with CPVC or Spears® before use. Contact with incompatible chemicals could cause serious personal injury, property damage, and product damage.

Spears® FlameGuard® CPVC Fire Sprinkler Pipe should be stored indoors with a maximum storage temperature of 110° F (43° C). If storing outdoors, the products must be covered with a non-transparent material to prevent extended exposure to sunlight. Brief exposure to direct sunlight on the job site may result in color fade, but it will not affect the physical properties. Spears® FlameGuard® CPVC Fire Sprinkler Fittings should be stored indoors in their original containers to keep them free from dirt and to help reduce the possibility of damage.

WARNING: Spears® FlameGuard® CPVC Fire Sprinkler Products must not be subjected to prolonged sunlight exposure. The use of pipe and fittings that have been damaged due to improper storage could cause serious personal injury, property damage, and product damage.

Reasonable care must be exercised in handling Spears® FlameGuard® CPVC Fire Sprinkler Products. DO NOT drop the products or drop anything on them.

WARNING: DO NOT install Spears® FlameGuard® CPVC Fire Sprinkler Products that have been scratched, split, or gouged. The use of pipe and fittings that have been damaged due to improper handling could cause serious personal injury, property damage, and product. Damaged fittings or sections of pipe must be discarded

One-Step Solvent Cement

Spears® FS-5 One-Step Low VOC Solvent Cement must be stored out of direct sunlight in an ambient temperature between 40° F (4° C) and 90° F (32° C). The solvent cement may be used for a period of two years from the date stamped on the container. Expired solvent cement must be discarded in an environmentally friendly fashion, in accordance with local regulations. To prolong the life of the cement, the containers must be kept tightly closed when not in use and covered as much as possible when in use.

WARNING:

- Spears® FS-5 One-Step Low VOC Solvent Cement is highly flammable. Eliminate all ignition sources.
- Avoid breathing vapors. Use only with adequate ventilation. Explosion-proof, general mechanical ventilation or local exhaust is recommended to maintain vapor concentrations below

recommended exposure limits. In confined or partially enclosed areas, a NIOSH approved organic vapor cartridge respirator with a full face-piece is recommended. Avoid frequent contact with skin. It is recommended that you wear PVA coated gloves and an impervious apron.

- Avoid contact with eyes. Splash-proof chemical goggles are recommended.
- Review the Material Safety Data Sheet (MSDS) and the important product information provided on the label for Spears® FS-5 One-Step Low VOC Solvent Cement.
- Failure to follow the above recommendations could result in death or serious personal injury.

Listings, Approvals, Application & Use

Spears® FlameGuard® CPVC Fire Sprinkler Products are fully tested and approved for use in wet pipe fire sprinkler systems by Underwriters Laboratories Inc., FM Global, and the Loss Prevention Certification Board. Spears® FlameGuard® CPVC Fire Sprinkler Products are approved for use in low pressure dry pipe or pre-action systems by Underwriters Laboratories Inc. Spears® FlameGuard® CPVC Fire Sprinkler Products are listed by NSF International for use in potable water systems, except where specifically stated otherwise. For specific listing information not covered in this manual concerning Factory Mutual, The Loss Prevention Certification Board or NSF International, please contact your nearest Spears® Regional Distribution Center.

NOTICE: National Fire Protection Association (NFPA) Standards 13, 13R, and 13D is the authority on fire sprinkler system design and installation and must be referenced in conjunction with this manual and all local codes. This manual is reviewed and approved by Underwriters Laboratories and all UL/ULC statements herein are considered an extension of Spears® FlameGuard® UL Listings

CAUTION: Spears® FlameGuard® CPVC Fire Sprinkler Products are NOT listed for outdoor applications. Outdoor installation could result in product failure and property damage and will not be covered under the Spears® FlameGuard® CPVC Fire Sprinkler Products warranty.

CAUTION: Spears® FlameGuard® CPVC Fire Sprinkler Products are to be used in wet pipe systems only, except as provided for dry pipe or pre-action systems in this manual. A wet pipe system is one that contains water and is connected to a water supply system so that the water will discharge immediately when the sprinkler is opened. A low pressure dry pipe or pre- action system is a piping system containing air or nitrogen under pressure that is released with the opening of a sprinkler which activates a special dry pipe valve allowing water to flow into the piping system and to the open sprinkler.

WARNING: Spears® FlameGuard® CPVC Fire Sprinkler Products must never be used for distribution of compressed air or other gases except as provided for under Low Pressure Dry Pipe and Pre-action Systems specified in this manual. Failure to follow this warning could result in product failure, property damage and severe personal injury or death.

Light Hazard Occupancies

Spears® FlameGuard® CPVC Fire Sprinkler Products are UL Listed for use in Light Hazard Occupancies, as defined in the NFPA 13. In accordance with NFPA 13, 2016 Edition paragraph 6.3.9.6, "Non-Metallic pipe listed for light hazard occupancies shall be permitted to be installed

in ordinary hazard rooms of otherwise light hazard occupancies where the room does not exceed 400 square feet." NOTICE: Local jurisdictions must approve of this exception.

Residential Occupancies

Spears® FlameGuard® CPVC Fire Sprinkler Products are UL Listed for use in: Residential occupancies up to and including four stories in height, as defined in NFPA 13R.

Residential occupancies, as defined in the Standard for the Installation of Sprinkler Systems in One and Two-Family Dwellings and Manufactured Homes, NFPA 13D.

Low Pressure Dry Pipe and Pre-action Systems

In accordance with the UL® Listing, Spears® FlameGuard® CPVC Fire Sprinkler Products may be used in Low Pressure Dry Pipe and Pre-action System applications in Light Hazard and Residential occupancies in accordance with NFPA 13, 13D and 13R when subject to the following additional limitations:

A CPVC Low Pressure Dry Pipe or Pre-action System is a piping system intended for use where piping could be subjected to freezing temperatures and water filled pipe cannot be utilized. The minimum rated temperature is -20° F (-29° C). Low Pressure Dry Pipe systems contain compressed air or nitrogen (gas) having an internal gage pressure of not more than 15 psig (105 kPa). These specially designed systems require separate control valve mechanisms for this application (supplied by others) that activate to release water into the dry piping section and to the sprinkler heads. The water-filled portion of the system control device must be in an area protected from freezing. It is the installer's responsibility to be sure the system is installed in accordance with the limitations of this manual and specifications of a Dry Pipe or Pre-action Fire Sprinkler System Design Engineer for proper control devices, pipe sizing, and other important design and maintenance criteria applicable to each project. CPVC dry systems must be designed with the following maximum water delivery time delay.

Occupancy Hazard*	Remote Sprinklers Open	Water Delivery Delay, sec.
Residential	1	15
Light	1	60

*As described in NFPA 13, Standard for the Installation of Sprinkler Systems.

Spears® FlameGuard® CPVC Fire Sprinkler Products are UL® Listed for use in Dry Pipe or Pre-action type systems when installed with UL® Listed Spears® FlameGuard®, or BlazeMaster® brands of CPVC Fire Sprinkler Products that are also Listed for this application.

CPVC installation in a Dry Pipe or Pre-action sprinkler system must be concealed (protected) by either:

- (1) A 3/8 in. thick or thicker gypsum wallboard;
- (2) A suspended membrane ceiling with lay-in panels or tiles having a weight of not less than 0.35 lb/ft² when installed with metallic support grids; or
- (3) 1/2 in. plywood soffits.

CPVC pipe and fittings used in a Dry Pipe or Pre-action System are not for use in combustible concealed spaces where sprinklers are required by NFPA 13, 13D and 13R.

Pipe and fittings are for indoor use only, down to a minimum temperature of -20° F (-29° C).

CPVC pipe in Dry Pipe or Pre-action Systems must be installed with proper pitch to allow system drainage for removal of water. NFPA 13 requires a minimum pitch of 1/2 inch per 10 feet (4 mm/m) for main lines and branch lines in areas subject to freezing.

The following types of sprinklers and arrangements shall be permitted for dry pipe systems, current NFPA 13:

- (1) Upright sprinklers;
- (2) *Listed dry sprinklers;
- (3) Pendent sprinklers and sidewall sprinklers installed on return bends, where the sprinklers, return bend, and branch line piping are in an area maintained at or above 40° F (4° C);
- (4) Horizontal sidewall sprinklers installed so that water is not trapped;
- (5) Pendent sprinklers and sidewall sprinklers, where the sprinklers and branch line piping are in an area maintained at or above 40° F (4° C), the water supply is potable, and the piping for the dry pipe system is copper or CPVC specifically listed for dry pipe applications.

Residential sprinklers used in CPVC Dry Pipe Systems shall be specifically listed for such use.

Low Pressure Dry Systems have a maximum installed air pressure of 15 psi (1 BAR). Air (or Nitrogen) supply for charging the system must be filtered, clean, oil-free, and must be pressure regulated to assure that the 15 psi (1 BAR) pressurization is not exceeded.

WARNING – Oil in the air (or Nitrogen) supply can cause environmental stress cracking in CPVC materials.

WARNING – Over pressurization can result in system damage or serious injury.

The system must be hydrostatically tested in accordance with System Acceptance Testing (Hydrostatic Pressure Test) as specified in this manual.

Concealed Installations

In concealed installations, the minimum protection shall be one layer of 3/8-inch gypsum wallboard, 1/2-inch plywood soffits, or a suspended membrane ceiling with lay-in panels or tiles having a minimum weight of not less than 0.35 lbs/ft² when installed with metal support grids. The minimum protection for residential occupancies, defined in NFPA 13D and 13R, may consist of one layer of 1/2-inch plywood.

Spears® FlameGuard® CPVC Fire Sprinkler Products must be used in sprinkler systems employing sprinkler heads rated at 225° F (107° C) or lower.

NOTICE

- Spears® FlameGuard® CPVC Fire Sprinkler Products CANNOT be installed
- in spaces designated by NFPA 13 as combustible, concealed spaces that require sprinklers, unless the space is protected by sprinklers that are specifically Listed for the application.
- NFPA 13D and NFPA 13R permit the omission of sprinklers in combustible, concealed spaces. Spears® FlameGuard® CPVC Fire Sprinkler Products can be installed in these areas when sprinkling residential occupancies in accordance with these standards.

Combustible Concealed Installations with Specific Use Sprinklers

In accordance with UL Listing, Spears® FlameGuard® CPVC Fire Sprinkler Products can be used in specific light-hazard, combustible and noncombustible concealed spaces that require sprinkler protection when installed with UL Listed specific application sprinklers. The system must be installed in accordance with the applicable sprinkler manufacturer's information contained in their designated data sheets shown in parenthesis "()". These include: Victaulic Model V2502 (Submittal 40.09, Rev D) Upright Quick Response Sprinkler; Tyco Fire Products Model CC1 – 2.8 K-Factor (TFP630, July 2015) or Model CC2 – 5.6 K-Factor (TFP632, August 2016) or Model CC3 – 4.2 and 5.6 K-Factor (TFP633, December 2016) Combustible Concealed Space Sprinklers, Specific Application Upright; Viking VK900 COIN™ (Form F_110503 16.12.22 Rev 16.1) or VK901 COIN™ (Form F_021607 16.12.22 Rev 16.1) or VK950 COIN™ (Form F_081216 16.12.15 Rev 16.1) Quick Response Upright Sprinklers for Specific Application; Reliable Model KFR-CCS 5.6 K-Factor (Bulletin 044 Rev C) Combustible Concealed Space Upright Sprinkler; and Globe Model "IC" GL5608 (Bulletin GL5608, September 2015) Interstitial Combustible Specific Application Upright Sprinkler.

NOTICE: When installing Spears® FlameGuard® CPVC Fire Sprinkler Products in combustible concealed areas where sprinklers are required, the specific application sprinkler must be used in accordance with its UL Listing. Contact the local authority having jurisdiction with questions concerning code requirements.

Combustible Attic Spaces with Specific Use Sprinklers

Product Description

In accordance with the UL Listing, Spears® FlameGuard® CPVC Fire Sprinkler Products may be installed within the attic space provided the attic space is protected with UL Listed Specific Application Attic Sprinklers. Specific Application Attic Sprinklers are sprinklers designed to provide protection of specific light hazard combustible, as well as non-combustible, attic spaces requiring sprinkler protection.

Installation Requirements

When using the Specific Application Attic Sprinklers, Spears® FlameGuard® CPVC Fire Sprinkler Products may be installed to feed the wet system sprinklers below the ceiling and exposed to feed wet system specific application attic sprinklers provided the system is installed in accordance with the applicable sprinkler manufacturer's information contained in their designated data sheets shown in parenthesis "()". These include: Tyco Fire Products Models BB, SD, HIP and AP (TFP610, August 2014) Specific Application Sprinklers for Protecting Attics; Reliable Models DD56-6, DD26-27, DD80-6 and DD80-27 (Bulletin 056, December 2016) Specific Application, Attic Sprinklers; Viking Model VK696 (Form F_042815 16.01.28 Rev 16.1) Attic Upright Specific Application Sprinkler or Model V-BB (Form F_042915 16.08.04 Rev 16.2) Specific Application Attic Sprinkler or Model V-SD (Form F_043015 16.02.19 Rev 16.1) Specific Application Attic Sprinkler.

Exposed Installations

Spears® FlameGuard® CPVC Fire Sprinkler Products are UL Listed for use in installations without protection (exposed), with the following restrictions:

Exposed CPVC Fire Sprinkler piping is installed below a smooth, flat, horizontal ceiling construction utilizing UL Listed support devices.

- Listed, Quick-Response, ordinary temperature-rated pendent sprinklers having deflectors installed within 8 inches from the ceiling. Listed, Residential, ordinary temperature-rated, pendent sprinklers located in accordance with their Listing. The maximum distance between sprinklers must not exceed 15 feet. The piping must be mounted directly to the ceiling.
- Listed, Quick-Response, ordinary temperature-rated horizontal sidewall sprinklers having deflectors installed within 6 inches from the ceiling and within 4 inches from the sidewall. Listed, Residential, ordinary temperature rated horizontal sidewall sprinklers located in accordance with their Listing. The maximum distance between sprinklers must not exceed 14 feet. The piping must be mounted directly to the sidewall.
- Listed, Quick-Response, upright sprinklers having a maximum temperature rating of 155° F (68° C) must be installed so that the deflectors are a maximum of 4" from the ceiling. The maximum distance from the ceiling to the centerline of the main run of pipe must be 7-1/2". The distance between a hanger and the centerline of an upright sprinkler shall not be less than 3in. (75mm). Rigid pipe hangers secured to the ceiling must be used.

Expanded Use with Light Hazard Extended Coverage and Residential Sprinklers

In accordance with the UL Listing, Spears® CPVC Fire Sprinkler products may be installed without protection (exposed) when subject to the following additional limitations.

The following installations shall be below a smooth, flat, horizontal ceiling construction and require the use of FS-5 one step solvent cement. The piping shall be mounted directly to the sidewall.

Listed quick response, 200° F (93° C) maximum temperature rated, horizontal sidewall sprinklers having deflectors installed within 12 inches (304 mm) from the ceiling and within 6 inches (152 mm) from the sidewall or Listed residential, 200° F (93° C) maximum temperature rated, horizontal sidewall sprinklers located in accordance with their Listing and a maximum distance between sprinklers not to exceed 14 feet (4.27 m).

The following installations shall be below a smooth, flat, horizontal ceiling construction, are limited to unobstructed construction, require the use of Schedule 80 fittings for sizes 1-1/2 in. and greater, and require the use of FS-5 one step solvent cement. The piping shall be mounted directly to the sidewall. • Listed light hazard, extended coverage, quick response, 175° F (79° C) maximum temperature rated, horizontal sidewall sprinklers having deflectors installed within 12 inches (304 mm) from the ceiling and within 6 inches (152 mm) from the sidewall, a maximum distance between sprinklers not to exceed 16 feet (4.87 m), and an application density not less than 0.10 gpm/ft² (4.08 mm/min).

- Listed residential, 165° F (74° C) maximum temperature rated, horizontal sidewall sprinklers having deflectors installed within 12 inches (304 mm) from the ceiling and within 6 inches (152 mm) from the sidewall, a maximum distance between sprinklers not to exceed 18 feet (5.48 m), and an application density not less than 0.10 gpm/ft² (4.08 mm/min).
- Listed light hazard, extended coverage, quick response 165° F (74° C) maximum temperature rated, horizontal sidewall sprinklers having deflectors installed within 12 inches (304 mm) from the ceiling and within 6 inches (152 mm) from the sidewall, a maximum distance

between sprinklers not to exceed 18 feet (5.48 m), and an application density not less than 0.10 gpm/ft² (4.08 mm/min).

- Listed light hazard, extended coverage, quick response, 155° F (68° C) maximum temperature rated, horizontal sidewall sprinklers (manufactured by Reliable Automatic Sprinkler Co. Inc. SIN RA0362) having deflectors installed within 12 inches (304 mm) from the ceiling and within 6 inches (152 mm) from the sidewall, a maximum distance between sprinklers not to exceed 24 feet (7.31 m), and a flow not less than 40 gpm (152 L/min) per sprinkler.

Spears® FG-3 installation instructions must be referenced for complete information regarding installation. Additional requirements may be listed in NFPA 13, 13D and 13R.

Unfinished Basements with Exposed Solid Wood Joist

NOTICE: Use of Spears® FlameGuard® CPVC Fire Sprinkler Products is limited to basements where the quantity and combustibility of contents is low and fires with relatively low rates of heat release are expected. Refer to NFPA 13D, "Standard for Installation of Sprinkler Systems in One and Two Family Dwellings and Manufactured Homes", for more information regarding installation in unfinished basements with exposed, solid wood joists.

Spears® FlameGuard® CPVC Fire Sprinkler Products can be installed in unfinished basements with exposed, solid wood joists with the following limitations:

1. The ceiling shall be horizontal and constructed utilizing nominal 2 in. x 10 in. solid wood joists on 16 in. centers.
- OR -
The ceiling must be horizontal and constructed utilizing nominal 2 in. x 12 in. solid wood joists on 16 in. centers. When installing Spears® FlameGuard® CPVC Fire Sprinkler Products in conjunction with 2 in. x 12 in. solid wood joists, the maximum system working pressure under flowing conditions must not exceed 100 psi and the maximum system working pressure under non-flowing conditions must not exceed 175 psi.
2. Schedule 80 fittings are required for installations involving 1-1/2" through 3" piping.
3. The distance from the floor to the bottom of the solid wood joists must be between 7 ft and 8 ft.
4. All system mains shall be run perpendicular to the joists. All branch lines shall be run parallel to the joists.
5. When the total protected area exceeds 1,000 square feet, blocking shall be utilized to divide the area into individual compartments not exceeding 1,000 square feet.
6. The maximum length along the joist must not exceed 32 feet. When the length exceeds 32 feet, blocking must be utilized. The blocking must be constructed of minimum 1/2 in. plywood and shall be the full depth of the wood joists. Refer to drawing below.

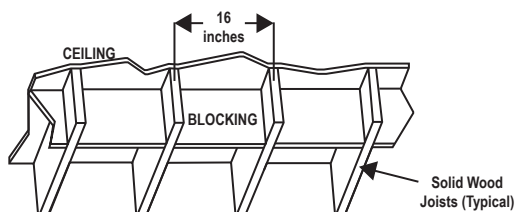

Center Wall Riser with Center Room Main

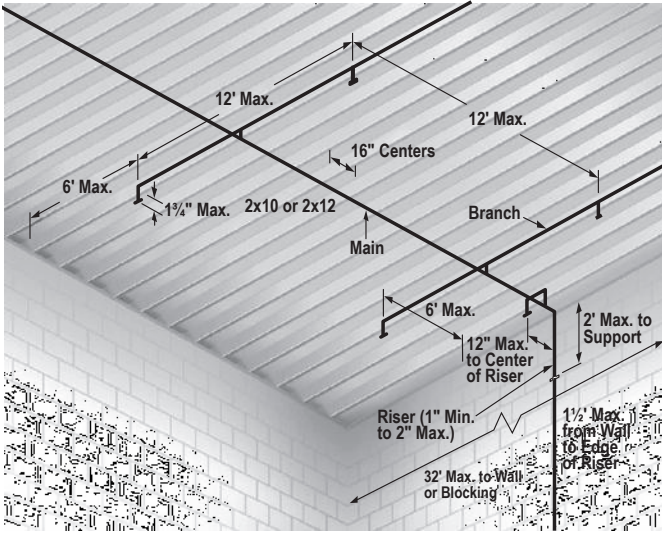

Center Wall Riser with Main at Wall

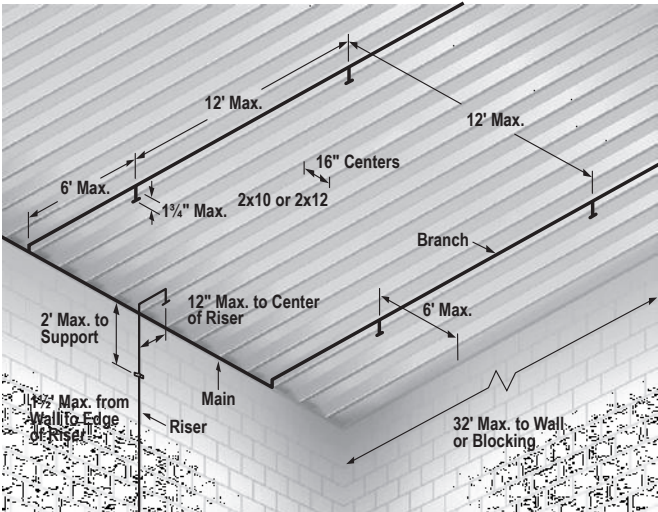

Riser in Corner

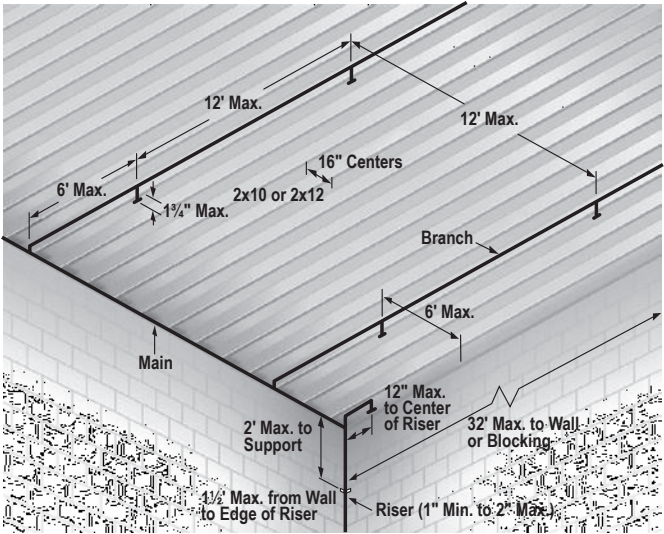

7. Listed residential pendent sprinklers with a maximum temperature rating of 155° F and a minimum K-factor of 3.0 must be used for this type of installation. **NOTE:** The maximum sprinkler spacing shall not exceed 12 feet.
8. The system must be designed to UL Listed flows for the sprinklers being used. However, the flow must not be less than 11 gpm per sprinkler. Sprinklers must be installed with the deflectors below the solid wood joists for future installation of a finished ceiling. However, deflector placement must not exceed 1-3/4 inches below the solid wood joist (refer to following Figures "A" and "B"). For more information, refer to NFPA 13D, "Standard for Installation of Sprinkler Systems in One and Two Family Dwellings and Manufactured Homes".

Branches Supported with Blocking

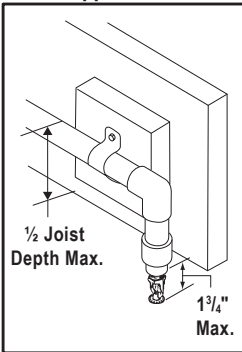

FIGURE "A"

Branches Supported with Hangers

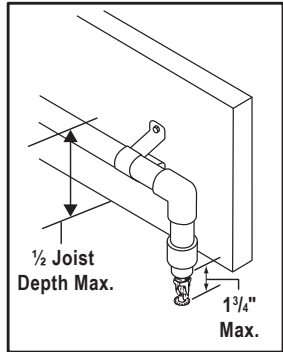

FIGURE "B"

9. When installing Spears® FlameGuard® CPVC Fire Sprinkler Products perpendicular (system mains) to the solid wood joists, UL Listed support devices for thermoplastic sprinkler piping or other UL Listed support devices shall be used which mount the piping directly to the bottom of the solid wood joists. In addition, it is acceptable to cut holes in the solid wood joists at or below the center of the depth of the solid wood joist for support. Holes must be oversized to allow for movement and must be located in an area that will not compromise joist integrity. Consult the authority having jurisdiction for more information regarding structural integrity.
10. When installing Spears® FlameGuard® CPVC Fire Sprinkler Products parallel (branch lines) to the solid wood joists, the pipe and fittings must be installed in the cavity below the bottom of the ceiling and above the bottom of the joist. Branch lines must be located at or below the center of the depth of the solid wood joist. UL Listed support devices must be used to mount piping directly to nominal 2 in. wood blocking. In addition, UL Listed support devices can be used that offset the pipe a nominal distance of 1-1/2 in. from the solid wood joists.

Unfinished Basements with Exposed Composite Wood I-Joists or Exposed Solid Wood Joists with Expanded Sprinkler Spacing in accordance with NFPA 13D

In accordance with UL Listings, Spears® FlameGuard® CPVC Fire Sprinkler Products may be installed without protection (exposed) in unfinished basements in accordance with NFPA 13D when installed to the following additional limitations:

1. The ceiling shall be horizontal and constructed utilizing composite wood I-joists with a nominal depth of 11-7/8 inches on up to 24-inch centers, or utilizing solid wood joists with a nominal size of depth of 12 inches or less on up to 24-inch centers.
2. The distance from the floor to the bottom of the solid wood joist or composite wood I-joists shall be between 7 feet and 10 feet.
3. Listed residential pendent sprinklers with a maximum temperature rating of 155°F and a minimum K-factor of 4.9 are to be used for this installation. The maximum sprinkler spacing shall not exceed 16 feet. The maximum sprinkler coverage area is to be 16 feet by 14 feet spaced with the 16-foot dimension along the joists and the 14-foot dimension across the joists. Lesser areas are also permitted. The system is to be designed based upon the listed flows for the sprinkler selected except that the flow for a single sprinkler or for multiple sprinklers flowing is to be not less than 13 gpm per sprinkler. The sprinklers are to be installed with their deflectors a maximum of 1-3/4 inches below the bottom of the solid wood joist or composite wood I-joists in anticipation of future installation of a finished ceiling. (see NFPA 13D, Section 8.2.4, 2010 Edition)
4. All system mains shall be run perpendicular to the joists. All branch lines shall be run parallel to the joists. Schedule 80 fittings shall be used for sizes 1-1/2 inch and larger.
5. All solvent cement joints shall be made with FlameGuard® FS-5 One Step Solvent Cement (or with competitor TFP-500, BM-5, FP-1000.).
6. When the total protected area exceeds 1,000 square feet, blocking shall be utilized to divide the area into individual compartments not exceeding 1,000 square feet. The maximum length along the joist shall not exceed 32 feet. When the length exceeds 32 feet, blocking shall be utilized. The blocking shall be constructed of minimum 1/2 inch

plywood or batt insulation with a minimum thickness of 3-1/2 inches. These blocking materials shall be the full depth of the joists. When batt insulation is used as blocking, it must be a single piece secured in place with metal wire netting which must encase the insulation on both of the exposed sides. The metal wire netting is required to hold the insulation in place and prevent it from being dislodged or repositioned over time. It is acceptable for items such as piping, wires, ducts, etc. to penetrate the blocking. The gap between the item penetrating the blocking and the blocking should be minimized. For installations where the gap exceeds 1/4 inch, the gap shall be filled with insulation, caulking, or other suitable material.

7. When installing Spears® FlameGuard® CPVC Fire Sprinkler piping perpendicular (system mains) to the joists, listed support devices for thermoplastic sprinkler piping or other listed support devices shall be used which mount the piping directly to the bottom of the solid wood joist or composite wood I-joists. As an alternative to mounting the pipe and fittings below the solid wood joist or composite wood I-joists, it is also acceptable to cut holes in the joists at or below the center of the depth of the joist for support – the holes should be oversized to allow for movement and located to not impair the structural integrity of the joists. Refer to the composite wood I-joint manufacturer's product data for specific instructions concerning the placement of any holes in the joists.

NOTICE: When drilling holes in the solid wood joists or composite wood I-joists, the structural integrity must be maintained. Consult the Authority Having Jurisdiction (AHJ) or building code for requirements.

8. When installing Spears® FlameGuard® CPVC Fire Sprinkler piping parallel (branch lines) to the solid wood joist or composite wood I-joists, the pipe and fittings shall be installed in the cavity below the bottom of the ceiling and above the bottom of the joist. The branch lines shall be located at or below the center of the depth of the joist. The pipe shall be installed utilizing listed support devices for thermoplastic sprinkler piping or other listed support devices which mount the piping directly to nominal 2-inch wood blocking or listed support devices for thermoplastic sprinkler piping which offset the pipe a nominal distance of 1-1/2 in. from the joists.

This application for Spears® FlameGuard® CPVC Fire Sprinkler Products is limited to basements where the quantity and combustibility of contents is low and fires with relatively low rates of heat release are expected.

Extended Coverage Quick Response Sprinklers

In accordance with the UL Listing, Spears® FlameGuard® CPVC Fire Sprinkler Products may be installed without protection (exposed) when subject to the following additional limitations:

1. Exposed piping is to be installed below a smooth, flat, horizontal ceiling construction.
2. Listed pendent, light hazard, quick response, extended coverage sprinklers, 155° F maximum temperature rating having deflectors installed within 8 in. from the ceiling and a maximum distance between sprinklers not to exceed 20 ft. with an application density of at least 0.10 gpm/sqft.
3. Listed pendent residential sprinklers, 155° F maximum temperature rating having deflectors installed within 8 in. from the ceiling and a maximum distance between sprinklers not to exceed 20 ft. with an application density of at least 0.10 gpm/sqft.

4. Listed horizontal sidewall, light hazard, quick response, extended coverage sprinklers, 165° F maximum temperature rating having deflectors installed within 6 in. from the ceiling and within 4 in. from the sidewall and a maximum distance between sprinklers not to exceed 18 ft. with an application density of at least 0.10 gpm/sqft.
5. Listed horizontal sidewall residential sprinklers, 165° F maximum temperature rating having deflectors installed within 6 in. from the ceiling and within 4 in. from the sidewall and a maximum distance between sprinklers and not to exceed 18 ft. with an application density of at least 0.10 gpm/sqft.
6. When using fittings in the 1-1/2 in. and greater size only Schedule 80 fittings may be used.
7. The end use application is limited to unobstructed construction.
8. All solvent cement joints shall be made with Spears® FS-5 One Step Solvent Cement, or any other cements referenced on page 23 of this manual.

Return Air Plenum Installation

Spears® FlameGuard® CPVC Fire Sprinkler Products meet the combustibility requirements for thermoplastic sprinkler pipe, as described in the Standard for Installation of Air Conditioning and Ventilating Systems, NFPA 90A. Spears® FlameGuard® CPVC Fire Sprinkler Products may be installed in the plenum space adjacent to, but not over, an opening in the ceiling, such as a ventilation grill.

Garage Installations

Spears® FlameGuard® CPVC Fire Sprinkler Products are suitable for use in garages requiring sprinklers, as defined in NFPA 13R, with the following requirements:

Minimum protection consisting of either one layer of 3/8-inch thick gypsum or 1/2-inch thick plywood must be provided.

Listed pendent or sidewall sprinklers with a maximum temperature rating of 225° F (107° C) must be used.

All sprinklers must be installed per the manufacturer's published installation instructions.

The system must be installed per the requirements of NFPA 13R and these installation instructions.

Ambient Temperature Limitations

Spears® FlameGuard® CPVC Fire Sprinkler Products are suitable for use in areas where ambient temperatures are within the range of 35° F (2° C) to 150° F (65° C). The Loss Prevention Certification Board (LPCB) listing states the maximum ambient temperature shall not exceed 120° F (50° C).

High Temperature Areas

Spears® FlameGuard® CPVC Fire Sprinkler Products can be installed in areas, such as an attic, where the ambient temperature exceeds 150° F (65° C) if ventilation is provided or if insulation is used around the product to maintain a cooler environment.

WARNING: DO NOT install Spears® FlameGuard® CPVC Fire Sprinkler Products in areas where the ambient temperature exceeds 150° F (65° C) without adequate ventilation or insulation around the product to maintain a cooler environment.

Cold Temperature Areas

Spears® FlameGuard® CPVC Fire Sprinkler Products can be used in areas where the ambient temperature remains above 35° F (2° C). These products can also be used in an area subject to freezing temperatures if the sprinkler system installation is protected from freezing. Many standard cold weathers piping design and installation practices can be used to protect the system from freezing, including, but not limited to the use of low pressure dry pipe and pre-action systems (see titled section in this manual), the use of glycerin, insulation installation techniques, and pipe insulation. Contact the manufacturers for compatibility of their products with Spears® FlameGuard® CPVC Fire Sprinkler Products.

NOTE: Attention must be given to local insulating techniques and codes that require a particular method. Since very cold weather will make Spears® FlameGuard® CPVC Fire Sprinkler Products more susceptible to damage, extra care should be taken to avoid rough handling or impact to these products.

WARNING: DO NOT allow a sprinkler system to freeze. A frozen system will deactivate and the pressures built up can cause the sprinkler heads to open or damage the pipe and fittings.

Factory Pre-mixed antifreeze solutions of water and USP grade GLYCERIN are acceptable for use with Spears® FlameGuard® CPVC Fire Sprinkler Products. Refer to NFPA 13, NFPA 13R, NFPA 13D and consult the local authority having jurisdiction before using glycerin solutions in fire sprinkler applications.

WARNING: DO NOT use glycol-based antifreeze solutions. Glycol solutions are not chemically compatible with the CPVC material and can cause damage to the CPVC Fire Sprinkler System.

The following information can be used to determine the quantity of a pre-mixed glycerin based antifreeze solution needed to protect the piping system.

Nominal Pipe Size -inch	Actual mm Size	US Gallons of Water Per Foot
3/4 (DN20)	26,9	.0311
1 (DN25)	33,7	.0494
1-1/4 (DN32)	42,4	.0792
1-1/2 (DN40)	48,3	.1042
2 (DN50)	60,3	.1636
2-1/2 (DN65)	73,0	.2395
3 (DN80)	88,9	.3555

NOTE: The gallons per foot column can be used for calculations when adding pre-mixed glycerin antifreeze to the piping system for freeze protection. All fire protection systems winterized with glycerin solutions must conform to local, state, and NFPA requirements. Pre-mixed Glycerin based solutions are the only antifreeze solutions recommended for use. Glycol solutions are not chemically compatible with the CPVC material, and their use may result in damage to the CPVC Fire Sprinkler System.

Fire Sprinkler System Risers

In accordance with the UL Listing, Spears® FlameGuard® CPVC Fire Sprinkler Products may be used as system risers in accordance with NFPA 13D and 13R when subject to the following additional limitations:

1. When installed protected (concealed), the minimum protection shall consist of either one-layer of 3/8 in. (9.5 mm) thick gypsum wallboard or 1/2 in. (12.7 mm) thick plywood.
2. When installed without protection (exposed), the following limitations shall apply:

a) The riser shall be installed below a smooth, flat, horizontal ceiling construction. A Listed residential pendent sprinkler is to be installed with its deflector at the distance from the ceiling specified in the sprinkler Listing.

OR

The riser shall be installed below a horizontal unfinished basement ceiling (in accordance with NFPA 13D) constructed utilizing nominal 2 in. x 10 in. or nominal 2 in. x 12 in. exposed solid wood joists on 16 in. centers. A Listed residential pendent sprinkler is to be installed with its deflector a maximum of 1-3/4 in. below the bottom of the solid wood joist in anticipation of future installation of a finished ceiling.

- When installing Spears® FlameGuard® CPVC Fire Sprinkler Products in conjunction with 2 in. x 12 in. solid wood joists, the maximum system working pressure under flowing conditions shall not exceed 100 psi and the maximum system working pressure under static (nonflowing) conditions shall not exceed 175 psi.

b) The Listed residential pendent sprinkler is to have a maximum temperature rating of 155° F and a minimum K-factor of 3.0 and is to be installed at a maximum horizontal distance of 12 inches from the centerline of the riser. The system is to be designed based upon the Listed flows for the sprinkler being used. However, the flow must not be less than 11 gpm per sprinkler.

c) The riser shall be supported vertically within 2 feet of the ceiling or bottom of the joist.

d) The minimum riser diameter shall be 1 in. and the maximum riser diameter shall be 2 in.

e) The maximum distance between the wall(s) and the outside surface of the riser pipe shall be 1-1/2 in.

f) All solvent cement joints shall be made with Spears® FS-5, or any of the solvent cements referenced on page 25 of this manual.

g) These installations require the use of Schedule 80 fittings for riser sizes 1-1/2 in. and larger.

3. The system shall be installed per the requirements of NFPA 13, Support of Risers. Sections 9.2.5 (2016 Edition).
4. Spears® FlameGuard® CPVC Fire Sprinkler Products shall be installed

per the manufacturer's installation and design manual and this addendum.

5. Risers shall be supported by pipe clamps or by hangers located on the horizontal connection close to the riser. Only Listed hangers and clamps shall be used.
6. Vertical lines must be supported at intervals, described in 7 & 8 below, to avoid placing excessive load on a fitting at the lower end. Do this by using riser clamps or double bolt pipe clamps Listed for this service. The clamps must not exert compressive stresses on the pipe. If possible, the clamps should be located just below a fitting so that the shoulder of the fitting rests against the clamp. If necessary, a coupling can be modified and adhered to the pipe as a bearing support such that the shoulder of the fitting rests on the clamp. Follow the manufacturer's recommended cure time.
7. Recommended method for securing CPVC fire sprinkler pipe vertically. Place clamp below shoulder of fitting.

WARNING: Modified riser collar shall only be used to provide support to the riser and shall not be used to join two pieces of pipe.

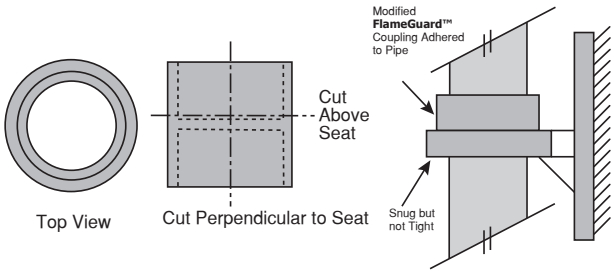

8. Do not use riser clamps that squeeze the pipe and depend on compression of the pipe to support the weight.
9. Hangers and straps shall not compress, distort, cut or abrade the piping and shall allow for free movement of the pipe to allow for thermal expansion and contraction.
10. Maintain vertical piping in straight alignment with supports at each floor level, or at 10 feet (3.05 m) intervals, whichever is less.
11. CPVC risers in vertical shafts or in buildings with ceilings over 25 feet (7.62 m), shall be aligned straight and supported at each floor level, or at 10 feet (3.05 m) intervals, whichever is less.

Underground Fire Service

Spears® FlameGuard® CPVC Sprinkler Products are UL Listed for use in underground water service when installation is in accordance with:

- ASTM D 2774, "Standard Recommended Practice for Underground Installation of Thermoplastic Pressure Piping"
- ASTM F 645, "Standard Guide for Selection, Design and Installation of Thermoplastic Water Pressure Piping Systems"
- NFPA 24, "Standard for the Installation of Private Fire Service Mains and Their Appurtenances"

The installation procedures detailed in this manual apply to CPVC Fire Sprinkler Products with solvent cemented joints in sizes 3/4 inch

through 3 inches.

C-UL Listing Requirements

Spears® FlameGuard® CPVC Fire Sprinkler Products are C-UL Listed in accordance with Canadian requirements for use in:

Light Hazard occupancies defined in the Standard for Installation of Sprinkler Systems, NFPA 13.

Residential occupancies as defined in the Standard for Installation of Sprinkler

Systems in Residential Occupancies up to Four Stories in Height, NFPA 13R.

Residential occupancies as defined in the Standard for Installation of Sprinkler Systems in One and Two-Family Dwelling and Manufactured Homes, NFPA 13D.

Protected Installations

When used with standard response sprinklers, protection shall be provided for Spears® CPVC piping products by ceilings, walls or soffits consisting of the following minimum protection: lath and plaster, 9.5 mm thick gypsum wallboard, 13 mm thick plywood or a suspended membrane ceiling with lay-in panels or tiles, classified with respect to surface burning characteristics having mass of not less than 1.7 kg/sq m and installed in steel suspension grids. The effectiveness of this protection can be impaired if penetrated by openings such as ventilation grills, exhaust fans connected to metal ducts serving washrooms excepted. Where such penetration is present, individual openings exceeding 0.03 sq m but not exceeding 0.71 sq m in an area must be located so that the distance from the edge of the opening to the nearest sprinkler does not exceed 300 mm. This piping shall not be used where such openings exceed 0.71 sq m in area. The effect of the presence of non-rated recessed lighting fixtures, public address speakers and other interruptions of the protective membrane has not been investigated.

Exposed Installations

As an alternative to the protection requirements, Spears® FlameGuard® CPVC Fire Sprinkler Products may be installed without protection (exposed) when subject to the following additional limitations:

- Exposed piping is to be installed below a smooth, flat, horizontal, fixed ceiling construction.
- Listed Quick-Response pendent sprinklers having deflectors installed within 8 inches from ceiling or Listed Residential pendent located in accordance with their Listing and a maximum distance between sprinklers not to exceed 15 feet.
- Listed Quick-Response horizontal sidewall sprinklers having deflectors installed within 6 inches from the ceiling and within 4 inches of the sidewall or Listed Residential horizontal sidewall sprinklers located in accordance with their Listing and a maximum distance between sprinklers not to exceed 14 feet.

During remodeling or repair, appropriate precautions shall be implemented to properly shield the piping from the protected occupancy.

Spears® FlameGuard® CPVC Fire Sprinkler Piping Products are to be installed in accordance with the requirements specified in NFPA 13, NFPA 13R or NFPA 13D and the National Building Code of Canada. Spears® FlameGuard® CPVC Fire Sprinkler Piping Products must be

installed in accordance with the other special installation and design criteria relative to handling, assembly, pipe hanger spacing, piping and sprinkler restraint, sprinkler temperature rating, piping location, testing procedures, friction loss characteristics and other applicable requirements specified in the manual. The use of Spears® FlameGuard® CPVC Fire Sprinkler Products in ceiling spaces above non-sprinklered areas has not been investigated.

Spears® FlameGuard® CPVC Fire Sprinkler Piping Products are Listed for use in wet pipe systems only, and are not Listed for outdoor use.

Spears® FlameGuard® CPVC Fire Sprinkler Products are C-UL Listed in accordance with Canadian requirements for use in combination with CPVC sprinkler products Listed in accordance with Canadian requirements and manufactured by GF Harvel (pipe), Ipex (pipe and fittings), TYCO Fire Products (pipe and fittings), Viking (pipe), or Nibco (fittings).

NOTICE: While Spears® FlameGuard® CPVC Fire Sprinkler Products are Listed for use in combination with other listed manufacturers' products, specific application approvals may not be the same amongst manufacturers. It is the installer's responsibility to verify suitability of products used in combination according to each manufacturer's installation instructions. Contact Spears® if you have questions on any application not addressed.

Spears® recommends the use of FS-5 One Step Low VOC Solvent Cement. However, Victaulic 899; Ipex BM-5; Central Sprinkler CSC-500; Nibco FP-1000 and TYCO Fire Products TFP-500 CPVC Solvent Cements can also be used in place of the FS-5 One Step Low VOC Solvent Cement, provided that the assembly and curing information referenced within this manual is used.

Factory Mutual Approvals



Spears® FlameGuard® CPVC Fire Sprinkler Products have been approved by Factory Mutual for use in exposed environments in Light Hazard Occupancies as defined in:

NFPA 13, the Standard for "Installation of Sprinkler Systems."

Residential occupancies, as defined in NFPA 13R, the Standard for "Installation of Sprinkler Systems in Low-Rise Residential Occupancies."

Residential occupancies, as defined in NFPA 13D, the Standard for "Installation of Sprinkler Systems in One and Two-Family Dwellings and Manufactured Homes."

Spears® FlameGuard® CPVC Fire Sprinkler Products are FM Approved for use with Fire Resistant Barriers for CPVC Pipe and Fittings in Light Hazard Occupancies under FM Approval of the Soffi-Steel™ System manufactured by Grice Engineering, Inc. Installation is to be made in accordance with the FM Approval requirements for the Soffi-Steel™ System.

Loss Prevention Certification Board LPCB



Spears® FlameGuard® CPVC Fire Sprinkler Products are approved for use as agreed between plastics suppliers, purchaser/installer, authority having jurisdiction and/or insurer in accordance with documented supplier Installation Instructions but subject to the following criteria taking precedence:

- Use of plastic pipe and fittings is subject to water authority agreement for the territory concerned.
- LPCB Approved quick response sprinklers shall be used with exposed (i.e., fire exposure) plastic pipe and fittings,
- Installation shall be made in accordance with Spears® publication FGUK-3, Design & Installation Manual for the UK.
- Plastic pipe and fittings are suitable for use only with wet pipe systems.
- Care should be exercised to ensure that joints are adequately cured, in accordance with the manufacturer's installation instructions prior to pressurization.
- Plastic pipe and fittings shall not be installed outdoor or used in underground water services.
- Where plastic pipe and fittings are exposed (i.e., fire exposure), the system shall be installed close to a flat ceiling construction.
- Sprinkler systems which employ plastic pipe and fittings shall be designed where possible to ensure no "no flow" sections of pipework in the event of sprinkler operation.

In addition, the maximum normal ambient temperature shall not exceed 120° F (50° C). The product shall only be installed in the UK by LPCB Certificated or Registered installing companies or by firms outside the UK who can provide evidence of personnel training in the installation of the product.

NSF International

Spears® FlameGuard® CPVC Fire Sprinkler Products have been approved by NSF® for potable water applications (unless otherwise noted). These products meet all applicable performance standards for a pressure rated application, as required in ANSI/NSF® Standard 14, and they comply with ANSI/NSF® Standard 61 for health effects. Spears® FlameGuard® CPVC Fire Sprinkler Products are tested against ASTM Standards F 438 and F 439.



Penetrating Fire-rated Walls & Partitions

Before beginning, consult the building codes and authorities having jurisdiction in your area. Several UL Classified, through-penetration firestop systems are approved for use with CPVC pipe. Consult the UL Building Materials Directory, the UL Fire Resistance Directory, and the system manufacturer for proper selection and application. Consult Spears® Manufacturing Company for further information.

Heat Sources & Open Ceiling Areas

Piping systems using Spears® FlameGuard® CPVC Fire Sprinkler Products must be laid out so that the piping is not closely exposed to heat producing sources, such as light fixtures, ballasts, and steam lines. Pipe must not be positioned directly over open ventilation grills. During remodeling or ceiling repair, appropriate precautions must be implemented to properly protect the piping.

Use With Other Manufacturers' Pipes, Fittings, & Solvent Cements

Spears® FlameGuard® CPVC Fire Sprinkler Products may be used only in connection with UL, FM and NSF certified CPVC products of other manufacturers. Use of Spears® FlameGuard® CPVC Fire Sprinkler Products in connection with CPVC products of other manufacturers which are not UL, FM and NSF certified may result in inappropriate product application and inconsistent determinations **in the event of warranty claims.**

Spears® FlameGuard® CPVC Fire Sprinkler Products are UL Listed for use in combination with UL Listed CPVC sprinkler products manufactured by GF Harvel (pipe), Ipex (pipe and fittings), TYCO Fire Products (pipe and fittings), Viking (pipe), or Nibco (fittings).

NOTICE: While Spears® FlameGuard® CPVC Fire Sprinkler Products are UL Listed for use in combination with other listed manufacturers' products, specific application approvals may not be the same amongst manufacturers. It is the installer's responsibility to verify suitability of products used in combination according to each manufacturer's installation instructions. Contact Spears® if you have questions on any application not addressed in this manual.

Spears® recommends the use of FS-5 One Step Low VOC Solvent Cement. However, Ipex BM-5; Nibco FP-1000 and TYCO Fire Products TFP-500 CPVC Solvent Cements can also be used in place of the FS-5 One Step Low VOC Solvent Cement, provided that the assembly and curing information referenced within this manual is used.

Installation & Joining

Make sure you follow all assembly and curing information referenced within this manual when installing Spears® FlameGuard® CPVC Fire Sprinkler Products. Failure to follow this instruction could cause improper curing, resulting in serious personal injury, significant property damage, joint leakage, or joint failure.

Before assembling any Spears® FlameGuard® CPVC Fire Sprinkler Products, you must inspect all components for cuts, scratches, gouges, split ends, or any other irregularities that have occurred during shipping and handling.

Solvent Cement Welded Joints

STEP 1 Cut Pipe Square.

CPVC pipe can be easily cut with a ratchet cutter, a wheel-type plastic tubing cutter, a power saw or a fine-toothed saw. Tools used to cut CPVC must be designed for plastic use and must be in good condition in accordance with the tool manufacturer's recommendations. It is important to cut the pipe square. A square cut provides the surface of the pipe with maximum bonding area.



If any indication of damage or cracking is evident at the pipe end, cut off at least 2 inches (50 mm) beyond any visible crack.

Notice: Avoid splitting the pipe when using ratchet cutters. Failure to do so may result in pipe failure or leakage.

- Only use ratchet cutters that contain a sharp blade (blades dull quickly).
- Only use ratchet cutters at temperatures of 50° F (10° C) or warmer.

- Only use well-maintained, good quality ratchet cutters capable of consistently cutting the pipe squarely.

STEP 2 Deburr & Bevel Pipe.

Burrs and filings can prevent proper contact between pipe and fitting during assembly, and must be removed from the outside and the inside of the pipe. A chamfering/reaming tool or a file is suitable for this purpose. A slight bevel (approximately 10° to 15°) shall be placed at the end of the pipe to ease entry of the pipe into the socket.

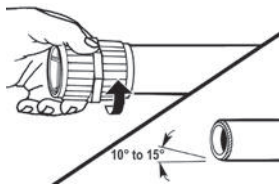

This will minimize the chance that the edges of the pipe will wipe solvent cement from the fitting socket during the insertion of the pipe.

STEP 3 Fitting Preparation

The pipe should enter the fitting socket easily one-third to two-thirds of the way (full interference fit). Contact between the pipe and fitting is essential in making a good joint. If the pipe bottoms with little interference (net fit), use extra solvent cement in making the joint. This contact allows the solvent cement (which is applied in the next step) to effectively join the pipe and fitting.

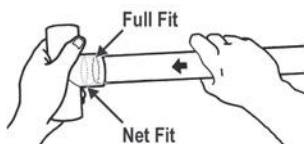

Using a clean, dry rag, wipe loose dirt and moisture from the fitting socket and pipe end. Moisture can slow the cure time and at this stage of assembly, excessive water can reduce joint strength.

STEP 4 Solvent Cement Application

CAUTION: Prior to using Spears® FS-5 One-Step CPVC solvent cement, or other approved CPVC fire sprinkler cement, review and follow all precautions found on the container labels, material safety data sheet, and Standard Practice for Safe Handling ASTM F 402. Failure to follow precautions may result in injury.

Special care shall be exercised when assembling CPVC fire sprinkler systems in temperatures below 40° F (4° C). In colder temperatures extra time must be allowed for the solvent cement to set and cure. Extra care should be taken to prevent damaging the pipe during handling. When solvent welding pipe and fittings in colder temperatures, make certain that the cement has not become lumpy or has "gelled". Gelled cement must be discarded.

At temperatures above 80° F (27° C) make sure both surfaces to be joined are still wet with cement during assembly. Higher temperatures and/or wind accelerate the evaporation of the volatile solvents in the cement. Pipe stored in direct sunlight may have surface temperatures 20° F to 30° F above the air temperature. If possible store the pipe and fittings, or, at least, the ends to be solvent welded, out of the direct sunlight prior to cementing. The solvents will penetrate hot surfaces more deeply. In conditions like this it is very important to avoid puddling the solvent cement inside the fitting socket.

Use a dauber that is properly sized for the pipe, no less than 1/2 the diameter of the pipe being assembled.

Only use solvent cements that have been specifically formulated and listed/ approved for use with CPVC fire sprinkler systems and approved by the pipe and fitting manufacturers.

Vigorously apply a heavy, even coat of cement to the outside pipe end. Apply a medium coat to the fitting socket. Pipe sizes 1-1/4 inch (DN32, 32mm) and above shall always receive a second cement application on the pipe end. **FIRST APPLY CEMENT ON THE PIPE END, THEN IN THE FITTING SOCKET, AND, FINALLY, ON THE PIPE END AGAIN.**

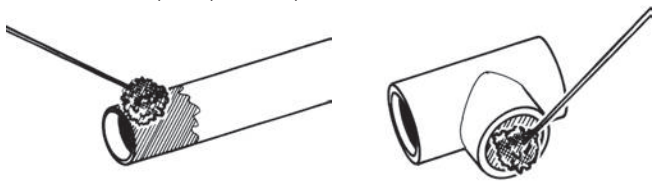

Notice: Too much solvent cement can cause clogged waterways or weaken the wall of the pipe or fitting and result in pipe failure or leakage.

- Do not allow excess cement to puddle in the pipe and fitting assembly. To prevent this puddling, apply a lighter coating of solvent cement to the inside of the fitting socket than the outside of the pipe.
- Wipe off excess cement on the outside of the joint. The solvents will evaporate, but the solvent cement inside the fitting will stay there.
- Take care to prevent cement from running into the threads of Sprinkler Head Adapters and Adjustable Sprinkler Head Adapters. Where possible, it is recommended to pre-install head adapters on to pre-cut Drops (section of pipe) and allow to achieve initial set in the inverted position. The head adapter and drop combination can then be installed into the system fitting.

STEP 5 Assembly

After applying cement, immediately insert the pipe into the fitting socket, while rotating the pipe one-quarter turn until the pipe bottoms out at the fitting stop. Rotate the pipe as it is inserted into the fitting not after it has bottomed out in the fitting. Properly align the fitting for the installation at this time. Pipe must bottom to the stop. Hold the assembly for 30 seconds to ensure initial bonding. A bead of solvent cement should be evident around the pipe and fitting juncture. If this bead is not continuous around the socket shoulder, it may indicate that insufficient cement was applied. If insufficient cement is applied, the fitting must be cut out and discarded. Cement in excess of the bead should be wiped off with a rag.

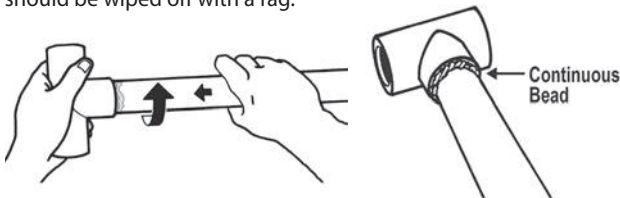

Notice: Failure to allow sprinkler head adapter fitting joints to cure before installing sprinklers may result in cement in the sprinkler waterway.

- Install sprinkler heads only after all the CPVC pipe and fittings, including the sprinkler head adapters, are solvent welded and allowed to cure for a minimum of 30 minutes.
- Do not install sprinklers in the fittings prior to the fittings being cemented in place.

- Prior to installing any sprinklers, Spears® recommends the entire system including drops must be thoroughly flushed to remove all pipe shavings, dirt and debris left from installation. Fill lines slowly and bleed air from the farthest and highest point, then flush with full flow.

Exercise care when installing sprinklers. Allow sprinkler head fittings and previously joined fittings to cure for a minimum of 30 minutes prior to installing the sprinkler. When installing sprinklers, be sure to anchor or hold the pipe drop securely to avoid rotating the pipe in previously cemented connections.

Notice: Too much solvent cement can cause clogged waterways.

- Visually inspect sprinkler fittings to ensure that the waterway and threads are clear of any excess cement.
- Once the installation is complete and cured per Table I, II or III, then test the system as described in the System Acceptance Testing (Hydrostatic Pressure Test) section of this manual.

STEP 6 Set and Cure Times

Notice: Inadequate curing of solvent cement joints may cause pipe failure or leakage. Solvent cement set and cure times are a function of pipe size, temperature, relative humidity, and tightness of fit.

Cure times should be increased when moisture is present such as during cut-ins to live sprinkler lines. (NOTE: refer to Recommended Cut-In Procedures for System Modification or Repair section in this manual.) The assembly must be allowed to set, without any stress on the joint, for 5 minutes, depending on pipe size and temperature. Following the initial set period, the assembly can be handled carefully, avoiding significant stresses to the joint.

Refer to Tables I, II, and III for MINIMUM cure times prior to pressure testing.

Table 1: Minimum Cure Time Table for Pressure Test up to 225 psi (15.5 bar) Ambient Temperature During Cure			
Nominal Pipe Sizes	60° F to 120° F (16° C to 49° C)	40° F to 59° F (4° C to 15° C)	0° F to 39° F (-18° C to 3° C)
3/4" (DN20)	1 hour	4 hours	48 hours
1" (DN25)	1-1/2 hours	4 hours	48 hours
1-1/4" & 1-1/2" (DN32 & DN40)	3 hours	32 hours	10 days
2" (DN50)	8 hours	48 hours	Note 1
2-1/2" & 3" (DN65 & DN80)	24 hours	96 hours	Note 1

**Table 2: Minimum Cure Time Table for Pressure Test
up to 200 psi (13.8 bar)
Ambient Temperature During Cure**

Nominal Pipe Sizes	60° F to 120° F (16° C to 49° C)	40° F to 59° F (4° C to 15° C)	0° F to 39° F (-18° C to 3° C)
3/4" (DN20)	45 minutes	1-1/2 hours	24 hr.
1" (DN25)	45 minutes	1-1/2 hours	24 hr.
1-1/4" & 1-1/2" (DN32 & DN40)	1-1/2 hours	16 hours	120 hours
2" (DN50)	6 hours	36 hours	Note 1
2-1/2" & 3" (DN65 & DN80)	8 hours	72 hours	Note 1

Note 1: For these sizes, the solvent cement can be applied at temperatures below 40° F (4° C). However, the sprinkler system temperature must be raised to a temperature of 40° F (4° C) or above and allowed to cure per the above recommendations prior to pressure testing.

**Table 3: Minimum Cure Time Table for Pressure Test up to
100 psi (6.9 bar) Ambient Temperature During Cure**

Nominal Pipe Sizes	60° F to 120° F (16° C to 49° C)	40° F to 59° F (4° C to 15° C)	0° F to 39° F (-18° C to 3° C)
3/4" (DN20)	15 minutes	15 minutes	30 minutes
1" (DN25)	15 minutes	30 minutes	30 minutes
1-1/4" (DN32)	15 minutes	30 minutes	2 hours

NOTICE: 1-1/2-inch and larger must be tested ONLY in accordance with Table 1 and Table 2.

WARNING: Make sure you allow the cement to cure according to the times listed in the charts for the pipe size and ambient temperature. These cure times have been tested and approved for Spears® FlameGuard® CPVC Fire Sprinkler products. DO NOT install any sprinkler heads until the piping system has cured for a minimum of 30 minutes.

The following guidelines provide an estimate of the quantities of Spears® FS-5 Low VOC Solvent Cement that you will need to complete the assembly.

Solvent Cement Requirements

Nominal Fitting Sizes	Solvent Cement Number of Joints Per Quart (estimated)
3/4" (DN20)	270
1" (DN25)	180
1-1/4" (DN32)	130
1-1/2" (DN40)	100
2" (DN50)	70
2-1/2" (DN65)	50
3" (DN80)	40

Threaded Connections

WARNING: Use only thread sealant recommended by Spears®. Other joint compounds or pastes may contain substances that could cause stress cracks in the CPVC. Cutting oils used in metal pipe threading cause stress cracking in CPVC materials. All cutting oils must be removed (Spears® recommends using a commercially available dishwashing soap). THE METAL PIPE MUST BE THOROUGHLY FLUSHED and degreased prior to assembly with CPVC systems. Some soap residues can damage CPVC piping.

STEP 1 APPLY SEALANT ONLY TO MALE THREAD

DO NOT use a combination of tape and paste sealants.

DO NOT clog waterway with excessive sealant.

DO NOT use any sealant on any Gasket Sealed Head Adapters.

RECOMMENDED SEALANT:

Spears® Manufacturing Company recommends the use of Spears® BLUE 75™ thread sealant, which has been tested for compatibility with Spears® products. Please follow the sealant Manufacturer's Application/Installation instructions. Choice of another appropriate thread sealant is at the discretion of the installer.



STEP 2 ASSEMBLE JOINT BY HAND

Thread Sprinkler Head in “finger tight” for initial assembly.

STEP 3 WRENCH MAKE-UP

Use an adjustable wrench on the flats of the Head Adapter and Wrench recommended by Sprinkler Manufacturer for the Head. Generally, wrench make-up of 1 to 2 turns beyond finger tight is sufficient. Avoid “backing up” the wrenched assembly.

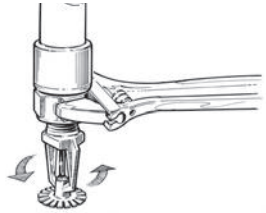

For Sprinkler Head Adapter connections:

	Standard Metal Thread	Special Reinforced (SR) Plastic Thread
Min. Torque:	15 ft.-lbs.	5 ft.-lbs.
Max. Torque:	20 ft.-lbs.	10 ft.-lbs.

For Female Adapter transitions to metal pipe, tighten hand-tight plus 1-1/2 turns.

DO NOT over-tighten.

IF A TAPE SEALANT MUST BE USED:

1. Use TFE tape no less than 3.5 mil thick.
2. Initial wrap must fully cover the thread end.
3. Wrap clockwise with standard pipe threads.
4. For Head Adapters, use **ONLY 2 - 3 wraps** of tape and tighten to specified torque.
5. For Female Adapter transition to metal pipe, use **ONLY 5 - 5-1/2 wraps** of tape and tighten hand-tight plus 1-1/2 turns.



Do Not use any sealant on any Gasket Sealed Head Adapters

WARNING: Always use commercially available strap wrenches. Do not use conventional pipe wrenches that can damage fitting.

WARNING: DO NOT over-torque any threaded connections. Generally, one to two turns beyond finger-tight are required to make a threaded connection. Factory testing has indicated that 15 - 20 ft-lbs of torque on Metal Thread Head Adapters and 5 - 10 ft-lbs on Special Reinforced (SR) Plastic Thread Head Adapters is adequate to obtain a leak free seal for Sprinkler Head Installations. Transitions to metal pipe using Female Adapters should be hand tight plus 1-1/2 turns.

NOTICE: Sprinkler heads must be installed only after all fire sprinkler pipe fittings, including the sprinkler head adapters, are cemented to the piping and have been allowed to cure for a minimum of 30 minutes. Plastic, threaded plugs are available for use in pressure testing. Before installing the sprinkler head, the sprinkler head fittings must be visually inspected or probed with a wooden dowel to ensure that the waterway and threaded areas are free of any excess cement that may restrict the flow of water.

TorqueSafe™ Gasket Sealed Thread Connections

This type of connection can only be made when using the FlameGuard® TorqueSafe™ Gasket Female Sprinkler Head Adapter. This special adapter has a special thread with gasket for sealing the sprinkler head. The adapter provides a special thread insert that can be rotated for proper frame alignment during installation. **Warning: DO NOT USE ANY TYPE OF THREAD SEALANT** when installing this adapter. Use of tape or paste sealant may impair proper sealing and function of the adapter.

STEP 1 INSTALL SPRINKLER HEAD BY HAND

Check that elastomer gasket and threads are clean, dry and gasket is seated at the base of the adapter thread. Install sprinkler head hand tight into adapter. **DO NOT use any thread sealant!**



NO Tape — NO Paste



Hand install until snug.

STEP 2 WRENCH ALIGNMENT

With wrench on sprinkler head, rotate sprinkler head clockwise until frame is properly aligned (Brass insert and Sprinkler head will rotate together. This will require approximately 10 to 25 ft-lbs torque at final orientation). **Caution: DO NOT use back-up wrench on brass insert flats.**

NEVER Reverse or Back up Threaded Assembly. If over-adjusted, continue to rotate clockwise until properly aligned.

NOTE: Back-up wrench may be applied to brass insert flats ONLY for removal of sprinkler head if required.

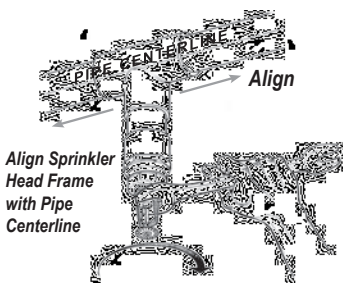

NOTICE: Sprinkler heads must be installed only after all fire sprinkler pipe fittings, including the sprinkler head adapters, are cemented to the piping and have been allowed to cure for a minimum of 30 minutes. Plastic, threaded plugs are available for use in pressure testing. Before installing the sprinkler head, the sprinkler head fittings must be visually inspected or probed with a wooden dowel to ensure that the waterway and threaded areas are free of any excess cement that may restrict the flow of water.

Align Sidewall Sprinkler Head & Frame Horizontally

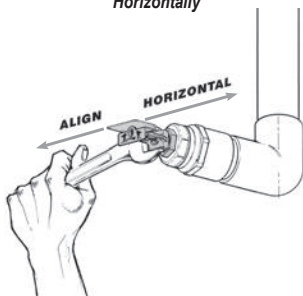

QuickTorque & SofTorque™ Gasket Sealed Thread Connections

This type of connection can only be made when using the FlameGuard® QuickTorque™ or SofTorque™ Gasket Female Sprinkler Head Adapter. These adapters both install the same. The difference being that the QuickTorque™ has a metal thread and the SofTorque™ has the patented Special reinforced (SR) thread. These special adapters have a special compressible gasket for sealing the sprinkler head. The Gasket can be compressed as specified for installation and can be further compressed for proper frame alignment during installation. **Warning: DO NOT USE ANY TYPE OF THREAD SEALANT** when installing these adapters. Use of tape or paste sealant may impair proper sealing and function of the adapter.

STEP 1 INSTALL SPRINKLER HEAD BY HAND

Check that elastomer gasket and threads are clean, dry. Install sprinkler head finger tight into adapter. **DO NOT use any thread sealant!**

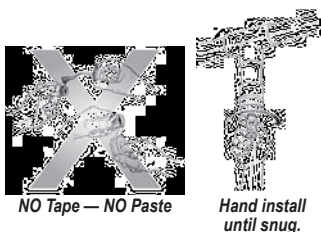

STEP 2 WRENCH TIGHTEN 1-TURN

With wrench on sprinkler head, rotate sprinkler head clockwise 1-Turn.



STEP 3 WRENCH ALIGNMENT

With wrench on sprinkler head, additionally rotate sprinkler head clockwise a maximum of 1 additional turn until frame is properly aligned. Follow this step for either vertical or horizontal head alignment.

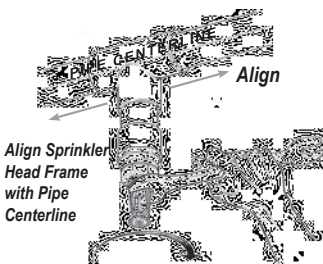

NOTICE Back-up wrench may be applied to the Adapter flats for removal of sprinkler head if required.

STEP 3 INSTALL PIPE

Insert pipe and Push in all the way to mark on pipe end.

NOTICE: GripLoc™ Expansion Repair Couplings will require thrust blocking restraints to keep unit from expanding under pressure

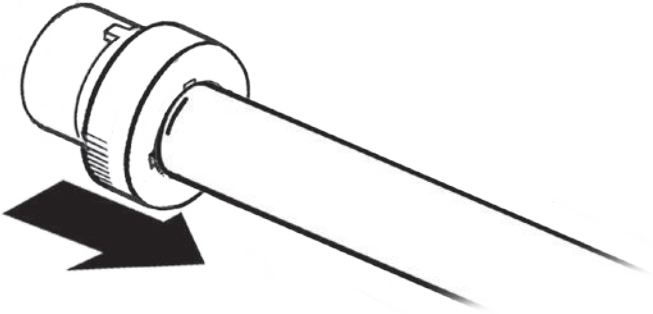

Painting Pipe & Fittings

CAUTION: The UL Listing DOES NOT cover painted CPVC fire sprinkler piping products. Use of certain paints, such as oil-based, can damage CPVC fire sprinkler piping products. **Use only a water-based latex or acrylic paint.** Before painting any CPVC fire sprinkler piping products, you must consult with your local authority having jurisdiction for restrictions.

Cleaning

Spears® FlameGuard® CPVC Fire Sprinkler Products can be cleaned using clean water and a soft towel. DO NOT use ammonia or other harsh chemical cleaners.

Transitions to Other Materials

Specifically designed female threaded adapters, grooved coupling adapters, and flanges are Listed for connecting systems incorporating Spears® FlameGuard® CPVC Fire Sprinkler Products to other materials, valves, and accessories. A special, reinforced female threaded adapter is available for connection to the sprinkler head.

Flanged Connections

Piping runs joined to the flanges must be installed in a straight line in relation to the flange to avoid stress at the flange due to misalignment. In addition, piping must be secured and supported to prevent lateral movement, which can create stress and damage the flange. Use only full-faced, Grade E, EPDM, 1/8" thick flange gaskets.

STEP 1 Attach Flange to Pipe.

The flange must be attached to UL Listed CPVC pipe following procedures for Solvent Cement Welded Joints in this manual.

NOTICE: When using “One-Piece” type flanges (fixed flange ring), care must be taken to align bolt holes with mating flange during solvent welding installation to pipe, or assure that pipe in system can be adequately rotated for correct hole alignment.

STEP 2 Position Gasket & Align Flanges.

With gasket between flanges, align gasket and mating flange bolt holes by rotating flange ring (see notice above).

STEP 3 Install Bolts, Nuts, & Washers.

Bolts should be lubricated with an acceptable anti-seize lubricant (such as IMS Copper Flake). Insert required bolts through flange bolt holes being sure to use two (2) flat washers per bolt, one at head and one below nut. Make sure that mating flanges are flush against gasket and properly aligned. Tighten nuts by hand until snug.

WARNING: Certain lubricants can cause stress cracking in CPVC materials.

STEP 4 Tighten Flange Bolts.

Establish uniform pressure over the flange face by tightening bolts in 5-ft. lbs. increments using the sequence shown in Figure 1 and specified torque values.

CAUTION: DO NOT use bolts to draw together improperly mated flanges. Care must be taken to avoid “bending” the flange ring when attached to a raised-face flange or wafer style valves.

Flange Data & Bolt Torque

The following recommendations are based on the use of two standard flat washers, standard nuts, and 1/8-inch thick EPDM full-face gasket. Actual field conditions may require a variation in these recommendations.

FIG. 1

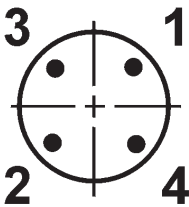

Flange Size Nominal In.	Recommended Torque ft-lbs (N-m)
3/4 to 1-1/2 (DN20 - DN40)	12 (16,3)
2 to 3 (DN50 - DN80)	25 (33,9)

Flange Size Nominal in.	Bolt Holes	Bolt Diameter inches (mm)	Minimum Bolt Length inches (mm)
3/4 (DN20)	4	1/2	2 (50,8)
		(12,7)	
1 (DN25)	4	1/2	2-1/4 (57,2)
		(12,7)	
1-1/4 (DN32)	4	1/2	2-1/4 (57,2)
		(12,7)	
1-1/2 (DN40)	4	1/2	2-1/2 (63,5)
		(12,7)	
2 (DN50)	4	5/8	3 (76,2)
		(15,9)	
2-1/2 & 3 (DN65 & DN80)	4	5/8	3-1/4 (85,6)
		(15,9)	

Grooved Coupling Adapters

Spears® FlameGuard® CPVC Grooved Coupling Adapters are designed for use with Victaulic Style 75 and Style 77 Flexible Couplings. Other UL Listed couplings of similar flexible design may be used.

CAUTION: The use of rigid style couplings will damage the Grooved Coupling Adapter. Consult coupling manufacturer for proper selection.

STEP 1 Inspect Pipe & Adapter.

Check to ensure that both pipe and Grooved Coupling Adapter are free of indentations, projections, or roll marks on the gasket seating areas. Pipe end must be cut square and any loose scale, paint or dirt removed.

NOTICE: Use a standard grade "E" (EPDM) compound gasket with a green stripe or a grade "E," type "A" gasket with a purple stripe that is suitable for wet fire sprinkler service.

STEP 2 Inspect & Lubricate Gasket.

Be sure the gasket is clean and free of any cracks, cuts, or other defects that could cause leaks. DO NOT allow solvent cement to contact the sealing surface of the gasket. Lubricate the gasket with a compatible lubricant to prevent pinching and to assist in the seating and alignment process. Apply a thin layer of lubricant to the gasket lips and exterior surface. Pre-lubricated gaskets may be used. It is the installer's responsibility to determine both the gasket suitability and chemical compatibility of any lubricants. Consult gasket and lubricant manufacturers.

WARNING: Certain lubricants may contain petroleum based or other chemical that can damage the gasket or adapter. Verify the suitability of the lubricant with the manufacturer before use.

STEP 3 Align Components & Install Gasket.

Place the gasket over the pipe end making sure the gasket lip does not overhang the end of the pipe. Align the grooved coupling adapter with the end of the pipe and slide the gasket over the seating surface of the adapter, centering the gasket between the two grooves. Make sure the gasket is not pinched between the pipe and the adapter fitting. No portion of the gasket should extend into the grooves.

STEP 4 Install Coupling.

Place the coupling housings over the gasket, making sure the housing keys engage into the grooves of the pipe and the adapter fitting. Insert the bolts and apply the nuts finger-tight. Using a socket wrench or other appropriate tool, tighten the nuts alternately and equally until you achieve metal-to-metal contact at the housings' bolt pads.

WARNING: You must tighten the bolts alternately and evenly to achieve metal-to-metal contact at the housings' bolt pads.

Inspect the joints before and after pressure testing. Look for gaps between the bolt pads and for housing keys that are not inside the grooves. Ensure that the pipe alignment does not place undue stress on the grooved coupling adapters. The maximum recommended pipe hanger distance from the grooved coupling adapter fitting is shown in the following table.

Nominal Pipe Sizes	Maximum Recommended Hanger Spacing feet (meters)
1-1/4 (DN32)	6-1/2 (2,0)
1-1/2 (DN40)	7 (2,1)
2 (DN50)	8 (2,4)
2-1/2 (DN65)	9 (2,7)
3 (DN80)	10 (3,0)

As an added precaution to enhance the structural design of the system, it is suggested that a hanger or support be located at or near the grooved coupling adapter joint. This hanger or support can be on either side of the coupling. However, this is not a requirement, since the hanger spacing shown in the above table meets the minimum requirements established by UL.

Adjustable Sprinkler Head Adapter Installation

Spears® FlameGuard® CPVC Adjustable Fire Sprinkler Head Adapter comes pre-assembled. There is no need for lubrication. It is recommended that the adjustable sprinkler head adapter be adjusted completely "in" by hand before beginning the installation process.

STEP 1 Install Adapter on Drop.

The Adjustable Sprinkler Head Adapter must be installed in accordance with the approved procedures for Solvent Cement Welded Joints, as outlined in this manual. It is recommended that the drop/riser pipe be solvent cemented into the adjustable sprinkler head adapter first, and then into the drop/riser tee or elbow.

CAUTION: Care must be taken to prevent solvent cement from coming in contact with the internal O-ring seal or sealing surface. All pipe shavings, dirt and debris must be flushed from the drop prior to adjustment. DO NOT over extend the adjustment barrel. Extend only to the point that free movement stops or damage to internal sealing components may result.

STEP 2 Install Sprinkler Head.

Sprinkler head installation must be in accordance with the approved procedures for Threaded Connections, as outlined in this manual. The Adjustable Sprinkler Head Adapter has multiple wrench flats provided to hold the adjustment barrel while installing the sprinkler head. These same wrench flats must be used to adjust the sprinkler head adapter to its required position.

CAUTION: Never use wrenches, pliers, or any other tool on the threaded portion of the adjustment barrel. DO NOT over extend the adjustment barrel.

STEP 3 Adjust Finished Height.

The maximum range of travel is 1-5/8". Always use multiple wrench flats for making adjustments. Make adjustments slowly if system is pressurized in order to avoid inadvertently over extending adjustment barrel.

CAUTION: Care must be taken not to extend or retract the adjustment barrel excessively, since this may result in damage to the adapter. Adjust only to the point that free movement stops.

For the purpose of hydraulic calculations, the adjustable sprinkler head equivalent length of pipe in feet are as follows: 3/4"x1/2" = 6-ft., 1"x1/2" = 9-ft.

System Flushing Recommendation

Spears® recommends the entire system, including drops, be thoroughly flushed to remove all pipe shavings, dirt and debris left from installation prior to installing any sprinklers and testing. Fill lines slowly and bleed air from the farthest and highest point, then flush with full flow.

System Pre-Acceptance Air Test Provision

Spears® FlameGuard® systems can be tested with Oil Free Air (OFA) at a maximum of 25psi. This is not a substitute for the NFPA hydrostatic test of the system (see System Acceptance Testing), which is still required. This is to help contractors quickly test the system to make sure all components are not leaking.

The following safety concerns must be practiced and followed:

1. Use eye protection and other appropriate safety equipment
2. Use only Oil-Free Air or Nitrogen
3. Use only regulated pressure with a 25 psi over-pressure relief valve

Follow NFPA requirements for System Acceptance Hydrostatic testing.

Warning: Compressed air use in PVC and CPVC plastic systems is potentially hazardous and in most jurisdictions is prohibited for use in transport, storage or distribution of compressed air or gasses. Air is a compressible gas that can store far more energy than water when put under pressure because it can release this energy so rapidly. This potentially explosive nature can result in serious injury. All safety practices above MUST be followed.

System Acceptance Testing (Hydrostatic Pressure Test)

Once an installation is completed and joints are properly cured per the above recommendations, the system should be hydrostatically pressure tested with water at 200 psi (13.8 bar) for 2 hours. See Table II for curing conditions at 200 psi (13.8 bar).

The system should be pressure tested with water at 50 psi (3.4 bar) in excess of maximum pressure when the maximum system pressure is to be maintained in excess of 150 psi (10.3 bar). See Table I for curing conditions at 225 psi (15.5 bar).

Sprinkler systems in one- and two-family dwellings and mobile homes may be pressure tested with water at line pressure, after following Table III curing conditions.

When pressure testing, the sprinkler system shall be slowly filled with water and the air bled from the highest and farthest sprinkler heads before pressure testing is applied. Air must be removed from piping systems (plastic or metal) to prevent it from being locked in the system when pressure is applied. Entrapped air can generate excessive surge pressures that can result in bodily injury and/or property damage, regardless of the piping materials used.

If a leak is found, the fitting must be cut out and discarded. A new section can be installed using couplings or a union. Unions should be used in accessible areas only.

Recommended Cut-in Procedures for System Modification or Repair

Existing system modifications or repairs can be made using Spears® FlameGuard® CPVC Fire Sprinkler Products. In order to maintain full system integrity, the following procedure must be followed when making a system tie-in or repair by cutting into an existing system line. A careful review of all Joining Procedures must be made prior to making a cut-in on an existing system and the Minimum Cut-in Cure Times schedule listed below must be followed. A variety of fitting combinations can be used to tie into an existing system or replace a section between fixed cut-in points. These include using a socket Tee for add-ons or a socket Coupling for repairs in combination with a mechanical joint such as a union, grooved coupling adapter, or flange. Regardless of the components selected, the following must be adhered to:

STEP 1

System modification cut-ins should be made on the smallest diameter pipe section, in close proximity to the area of modification, capable of properly supplying the system change.

STEP 2

Carefully plan and measure prior to cutting into existing system. Be sure to provide adequate space and insure that full insertion into fitting sockets can be made during assembly.

Note: Allowance must be made for making a 1/4-turn twist when inserting the pipe into the fitting during assembly of the tee (or other component), especially on 1-1/2" and larger pipe sizes. This may require assembly of components in combination with the cut-in tee to create a short spool piece for final connection using socket unions, flanges, or grooved coupling adapters.

STEP 3

Review all Installation & Joining procedures prior to commencing cut-in (including square cutting, deburring & beveling, cleaning, dry fit checks).

STEP 4

Depressurize and drain existing line prior to making the cut-in.

STEP 5

Connect to the existing system prior to proceeding with the modification or repair.

STEP 6

All pipe shavings, dirt, debris must be removed from the cut-in system and, water and residual moisture must be removed from all solvent cement areas. Vacuum lines and wipe dry with a clean dry rag. Moisture and dirt will slow the curing and can affect joint strength.

STEP 7

Use only a new can of approved solvent cement when making cut-in connections. Verify cement expiration date on can prior to use.

STEP 8

Cut-ins for modifications or system repairs are often made under less than ideal situations as compared to new installations. As a result, the following specified Minimum Cut-in Cure times must be used.

Minimum Cut-in Cure Times

Ambient Temperature During Cure			
Pipe Size Nominal In.	60° F to 120° F (16° C to 49° C)	40° F to 59° F (4° C to 15° C)	0° F to 39° F (-18° C to 3° C)
3/4" (DN20)	1 hours	4 hours	48 hours
1" (DN25)	1-1/2 hours	4 hours	48 hours
1-1/4" & 1-1/2" (DN32 - DN40)	3 hours	32 hours	10 days
2" (DN50)	8 hours	48 hours	Note 1
2-1/2" & 3" (DN65 - DN80)	24 hours	96 hours	Note 1

Note 1: Solvent cement can be applied at temperatures below 40° F (4° C) in all sizes. For the 2-1/2" & larger, the temperature must be raised to 40° F (4° C) or above and allowed to cure for the recommended times before the system is filled and pressurized. Cement, pipe or fittings brought in from colder outside temperatures must be brought up to room temperature before using the 60° F to 120° F cure schedule.

STEP 9

Following completion and proper cure, inspect for proper alignment and hanger placement prior to pressure testing.

STEP 10 To pressure test the system, slowly fill the system with water and make sure that all air is bled from the farthest and highest point before test pressure is applied. The system **MUST** be pressure tested in accordance with NFPA 13, NFPA 24, or any other applicable NFPA standard requirements. The system must be tested with water. The purpose of the hydrostatic pressure test is to check for leakage, and it may not identify improperly assembled joints. This test **MUST NOT** be considered a substitute for full compliance to these published installation instructions.

It is recommended that the portion of the sprinkler system containing the cut- in tee be isolated for pressure test where possible. The applied test pressure should not exceed 50 psi over the system pressure in order to minimize water damage in the event that a leak occurs.

WARNING: Spears® FlameGuard® CPVC Fire Sprinkler Products must never be used in a system for distribution of compressed air or other gases. Air must be removed from piping systems. Entrapped air can generate excessive surge pressures, regardless of the piping materials used. Failure to follow this warning could result in product failure, property damage and severe personal injury or death.

Engineering Data

Pipe and Fitting Specifications

Spears® FlameGuard® CPVC Sprinkler Pipe is produced in SDR 13.5 dimensions, as specified in ASTM F 442. Engineering data on Material Properties and Expansion & Contraction are provided in this manual for Spears® FlameGuard® CPVC Fire Sprinkler Pipe. Consult other manufacturers for applicable variations

Spears® FlameGuard® CPVC Sprinkler Fittings are produced in Schedule 40 and Schedule 80 dimensions for sizes 3/4" through 1-1/4", and in Schedule 80 for sizes 1-1/2" through 3", in accordance with ASTM F 437, ASTM F 438, and ASTM F 439 as applicable. These products are UL Listed FM/Approved for a rated working pressure of 175 psi (1200kPa) at 150° F (65° C) for sprinkler service and LPCB listed for a rated working pressure of 175 psi (1200kPa) at 120° F (49° C).

CPVC Fire Sprinkler Pipe Dimensions

SDR 13.5 (Ref. ASTM F442)			Weight lbs/ft (kg/m)
Size Nominal inches	Average OD inches (mm)	Average ID inches	
3/4 (DN20)	1.050 (26,7)	0.874 (22,5)	0.168 (0,2)
1 (DN25)	1.315 (33,4)	1.101 (28,2)	0.262 (0,4)
1-1/4 (DN32)	1.660 (42,2)	1.394 (35,6)	0.418 (0,6)
1-1/2 (DN40)	1.900 (48,3)	1.598 (40,7)	0.548 (0,7)
2 (DN50)	2.375 (60,3)	2.003 (50,9)	0.859 (1,2)
2-1/2 (DN65)	2.875 (73,0)	2.423 (61,5)	1.257 (1,2)
3 (DN80)	3.500 (88,9)	2.950 (75,0)	1.867 (1,2)

Hydraulic Design

Hydraulic calculations for the sizing of systems incorporating Spears® FlameGuard® CPVC Fire Sprinkler Products must be calculated using a Hazen-Williams C value of 150. Pipe friction loss calculations must be made according to NFPA Standard 13. The following table shows the allowance for friction loss for fittings, expressed as equivalent length of pipe. For additional information regarding friction loss, contact Spears®.

Allowance for Friction Loss in Fittings

Equivalent Feet (meters) of Pipe

	3/4" 26,7 mm	1" 33,7 mm	1-1/4" 42,4 mm	1-1/2" 48,3 mm	2" 60,3 mm	2-1/2" 73,0 mm	3" 88,9 mm
Tee Run	1 (0,3)	1 (0,3)	1 (0,3)	1 (0,3)	1 (0,3)	2 (0,6)	2 (0,6)
Tee Branch	3 (0,9)	5 (1,5)	6 (1,8)	8 (2,4)	10 (3,1)	12 (3,7)	15 (4,6)
90° Elbow	4 (1,2)	5 (1,5)	6 (1,8)	7 (2,1)	9 (2,7)	12 (3,7)	13 (4,0)
45° Elbow	1 (0,3)	1 (0,3)	2 (0,6)	2 (0,6)	2 (0,6)	3 (0,9)	4 (1,2)
Coupling	1 (0,3)	1 (0,3)	1 (0,3)	1 (0,3)	1 (0,3)	2 (0,6)	2 (0,6)

Hangers & Supports

Since CPVC Fire Sprinkler pipe is rigid, it requires fewer supports than flexible, plastic systems. Spears® recommends use of hangers that are designed and listed for supporting the CPVC Fire Sprinkler pipe. However, some hangers designed for steel pipe may be used if their suitability is clearly established. These hangers must have a minimum 1/2-inch, load-bearing surface, and they must be selected to accommodate the specific pipe size. In addition, they cannot contain rough or sharp edges that contact the pipe, and they must not bind the pipe from axial movement. Vertical runs must be supported so that the weight of the run is not on a fitting or a joint.

Horizontal runs must be braced so that the stress loads (caused by bending or snaking pipe) will not be placed on a fitting or a joint. Support spacing is shown in the following table. See “Snaking/Deflection of Pipe” in this manual for information regarding bending or snaking CPVC Fire Sprinkler Pipe.

Pipe Size Nominal inches	Maximum Support Spacing feet (meters)	Wt. Water Filled Pipe lbs/ft (kg/m)
3/4 (DN20)	5-1/2 (1,7)	0.427 (0,635)
1 (DN25)	6 (1,8)	0.674 (1,003)
1-1/4 (DN32)	6-1/2 (2,0)	1.078 (1,604)
1-1/2 (DN40)	7 (2,1)	1.412 (2,101)
2 (DN50)	8 (2,4)	2.223 (3,308)
2-1/2 (DN65)	9 (2,7)	3.254 (4,842)
3 (DN80)	10 (3,0)	4.831 (7,189)

NFPA 13D permits “support methods comparable to those required by local plumbing codes.” The above hanger/support requirements must also be followed on NFPA 13D systems.

CAUTION: DO NOT use hanger items such as plumber’s tape or “nail-on” devices. Pipe hanger must comply with NFPA 13, 13D and 13R.

When a sprinkler head activates, a significant reactive force can be exerted on the pipe. With a pendent head, this reactive force can cause the pipe to lift vertically if it is not secured properly, especially if the sprinkler drop is from small diameter pipe. The pipe must be braced against the vertical lift-up with the closest hanger. Refer to the following illustration and Table A & B.

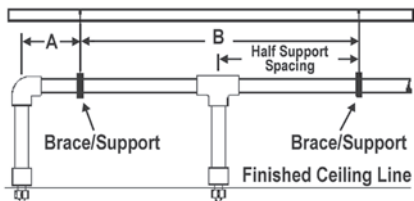

**Table A - Maximum Support Spacing Distance
End Line Sprinkler Head Drop Elbow**

Pipe Size Nominal inches	Line Pressure <100 psi (<689kPa)	Line Pressure >100 psi (>689kPa)
3/4 (DN20)	9 inches (228,6 mm)	6 inches (168,3 mm)
1 (DN25)	12 inches (304,8 mm)	9 inches (228,6 mm)
1-1/4 (DN32)	16 inches (406,4 mm)	12 inches (304,8 mm)
1-1/2 - 3 (DN40 - DN80)	24 inches (610,0 mm)	12 inches (304,8 mm)

Note: Support spacing can be increased by approximately 50% for lower pressures.

**Table B - Maximum Support Spacing Distance
Inline Sprinkler Head Drop Tee**

Pipe Size Nominal inches	Line Pressure <100 psi (<689kPa)	Line Pressure >100 psi (>689kPa)
3/4 (DN20)	4 feet (1,22 meters)	3 feet* (0,91 meters)
1 (DN25)	5 feet (1,52 meters)	4 feet* (1,22 meters)
1-1/4 (DN32)	6 feet (1,83 meters)	5 feet* (1,52 meters)
1-1/2 - 3 (DN40 - DN80)	7 feet (2,13 meters)	7 feet (2,13 meters)

Note: *Support spacing can be increased by one foot for lower pressures.

Numerous common methods are used to brace Fire Sprinkler Pipe. A few acceptable methods include: use of a standard band hanger by positioning the threaded support rod to 1/16-inch above the pipe (however, it is important that the rod does not contact the pipe), a wraparound U-hanger, a special escutcheon which prevents upward movement of the sprinkler through the ceiling or band hangers with Surge Restraints to provide surge protection for the system.

Pipe hangers are available that are tested and UL Listed for fire sprinkler service. These hangers comply with NFPA 13 requirements for use with CPVC fire sprinkler piping systems. The following illustrations depict several of these.

Band Hanger - designed to support CPVC piping systems when used in conjunction with a hanging steel threaded rod that is suspended from a ceiling or other flat, horizontal surface. The threaded rod must be leveled properly before installing the hanger and restraint.

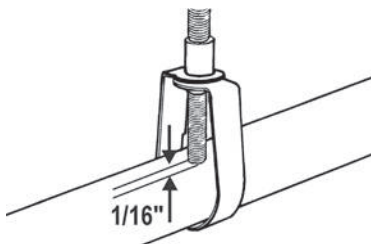

Surge Restraint - when installed with the Band Hanger, as shown below, provides surge protection for the system.

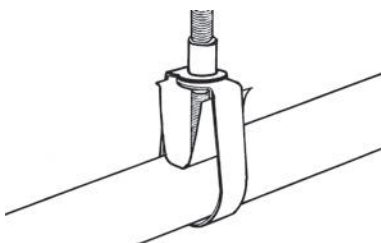

One Hole Wrap-Around Strap - designed to support CPVC piping systems only when the hanger tab is in the vertical position, and the screw-type fastener is in the horizontal position. The one-hole strap can be used as a pipe restrainer when the hanger tab is in the downward position, but it cannot be used as a hanger to hold any weight of the system. In addition, the one-hole strap can be used as a piping system guide when the system lies on top of the beam, and the beam supports the system's weight. The one-hole strap is not intended to support the CPVC piping system from under a ceiling or any other flat, horizontal surface. For this application, install two-hole strap.

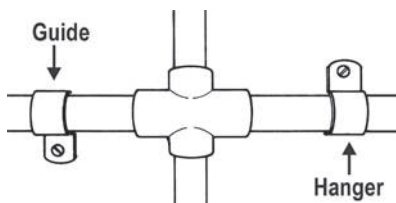

Two-Hole Strap - designed to support CPVC piping systems when attached to a flat, horizontal surface with the screw-type fasteners in the vertical position. In addition, the two-hole strap is designed to support CPVC piping systems when attached to a flat, vertical surface with one mounting tab in the vertical position and the screw-type fasteners in the horizontal position. The two-hole strap can be used as

a piping system guide when the system lies on top of a beam, and the beam supports the system's weight.

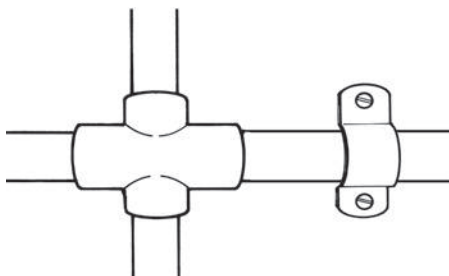

Two-Hole 90° Side Mount Strap - designed to support CPVC piping systems when attached to a horizontal beam with the screw-type fasteners in the horizontal position and the pipe hanging below the beam. The fastener's mounting edges are designed to allow the screws to be installed horizontally. This is a benefit when overhead clearance is limited. In addition, the 90° side mount strap can be used in a restrainer fashion when it is attached to the top of a beam, and the system lies on top of the beam.

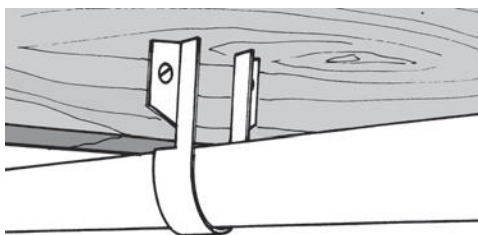

Riser Supports

Risers must be supported by pipe clamps or by hangers located on the horizontal connection close to the riser. Only Listed hangers and clamps can be used. Vertical lines must be supported at intervals to avoid placing excessive load on a fitting at the lower end. This can be done by using riser clamps or double-bolt pipe clamps listed for this service.

Hangers and supports must not compress, distort, cut, or abrade the piping, and they must allow free movement of the pipe for thermal expansion and contraction. **DO NOT** use riser clamps that squeeze the pipe and depend on compression of the pipe to support the weight.

Maintain vertical piping in straight alignment with supports at each floor level or 10-foot intervals, whichever is less. CPVC risers in vertical shafts or buildings with ceilings over 25 feet must be aligned straight and supported at each floor level or 10-foot intervals, whichever is less.

Clamps must not exert compressive stresses on the pipe. If possible, the clamps should be located directly below a coupling so that the shoulder of the coupling rests against the clamp. A coupling can be modified to achieve this by cutting a CPVC coupling just above the stop at the socket bottom. Then, cut this piece in half lengthwise to provide two halves that do not contain the stop. Follow the "Solvent

Cement Welding Instructions” to cement the two halves to the pipe at the required location, and make sure that the shoulder of the modified coupling rests on the clamp. Allow the assembly to cure before placing any stress on the joint.

WARNING: CPVC pipe and/or system components must not be used to provide structural support for the system. Care should be used when installing, hanging, or bracing to prevent unnecessary stress loads on the CPVC piping system.

Exposed Installations

For exposed installations that incorporate pendent or sidewall sprinklers, UL Listed support devices for thermoplastic sprinkler piping, or other listed support devices shall be used to mount the piping directly to the ceiling or sidewall.

Earthquake Bracing

Since CPVC fire sprinkler plastic piping is more ductile than metallic sprinkler pipe, it has a greater capacity to withstand earthquake damage. In areas subject to earthquakes, CPVC fire sprinkler systems should be designed and braced in accordance with local codes and NFPA Standard 13.

Trenching

The trench for underground fire service applications should be of adequate width to allow convenient installation, while at the same time being as narrow as possible. Minimum trench widths may be utilized by joining pipe outside of the trench and lowering it into the trench after adequate joint strength has been achieved.

CAUTION - Refer to the set and cure times listed in this manual for solvent cement joints. Failure to follow these cure times before installing piping systems in trenches could result in joint separation. Trench widths have to be wider where pipe is joined in the trench or where thermal expansion and contraction is a factor. Refer to the “Snaking/Deflection of Pipe” section.

Size		Trench Width	Light Traffic Ground Cover	Heavy Traffic Ground Cover
Nominal Diameter inches/mm	Actual Outside Diameter inches/mm	inches	Minimum inches	Minimum inches
3 and under 50 and under	3.500 and under 60.3 and under	8	12 to 18	30 to 36

- Water filled pipe should be buried at least 12 inches below the maximum expected frost line.
- It is recommended that thermoplastic piping be run within a metal or concrete casing when it is installed beneath surfaces that are subject to heavy weight or constant traffic, such as roadways and railroad tracks.

The trench bottom should be continuous, relatively smooth, and free of rocks. Where ledge rock, hardpan, or boulders are encountered, it is necessary to pad the trench bottom using a minimum of four inches of tamped earth or sand beneath the pipe as a cushion and for protection of the pipe from damage.

Sufficient cover must be maintained to keep external stress levels below acceptable design stress. Reliability and safety of service is of major importance in determining minimum cover. Local, state, and national codes may also apply.

Snaking/Deflection of Pipe

NOTICE –

- After CPVC pipe has been solvent cemented, snake the pipe, according to the following recommendations, beside the trench during its required drying time.
- Be especially careful not to apply any stress that will disturb the undried joint.
- Snaking is necessary to allow for any anticipated thermal contraction that will take place in the newly joined pipeline.

Snaking is particularly necessary on the lengths that have been solvent cemented during the late afternoon or a hot summer's day because their drying time will extend through the cool of the night when thermal contraction of the pipe could stress the joints to the point of pull out. This snaking is especially necessary with pipe that is laid in its trench (necessitating wider trenches than recommended) and is back-filled with cool earth before the joints are thoroughly dry. The following information can be used in determining maximum deflection allowable for various run lengths and pipe sizes.

**Maximum Bending Deflections in Inches
For Given Lengths of CPVC, SDR 13.5 (73° F)**

Pipe Size SDR 13.5	Length of Run (L) in Feet													
	2	5	7	10	12	15	17	20	25	30	35	40	45	50
	Pipe Deflection (D) in Inches													
3/4	1.3	7.8	15.4	31.3	45.1	70.5	90.6	124.4	195.9	282.1	383.9	-	-	-
1	1.0	6.3	12.3	25.0	36.0	56.3	72.3	100.1	156.5	225.2	306.6	400.4	-	-
1-1/4	0.8	5.0	9.7	19.8	28.5	44.6	57.3	79.3	123.9	178.4	242.8	317.2	401.4	-
1-1/2	0.7	4.3	8.5	17.3	24.9	39.0	50.1	69.3	108.2	155.9	212.2	277.1	350.7	433.0
2	0.6	3.5	6.8	13.9	20.0	31.2	40.0	55.4	86.6	124.7	169.7	221.7	280.6	346.4
2-1/2	0.5	2.9	5.6	11.4	16.5	25.8	33.1	45.8	71.5	103.0	140.2	183.1	231.8	286.2
3	0.4	2.4	4.6	9.4	13.5	21.2	27.2	37.6	58.8	84.6	115.2	150.4	190.4	235.1

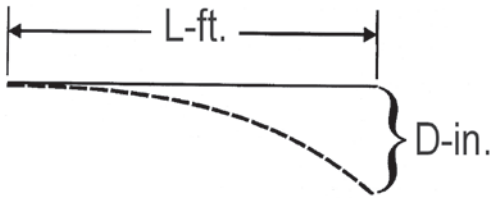

**Maximum Snaking Deflections in Inches
For Given Lengths of CPVC, SDR 13.5 (73° F)**

Pipe Size SDR 13.5	Length of Run (L) in Feet													
	2	5	7	10	12	15	17	20	25	30	35	40	45	50
Pipe Deflection (D) in Inches														
3/4	0.3	2.0	3.8	7.8	11.3	17.6	22.6	31.3	49.0	70.5	96.0	125.4	158.7	195.9
1	0.3	1.6	3.1	6.3	9.0	14.1	18.1	25.0	39.1	56.3	76.6	100.1	126.7	156.4
1-1/4	0.2	1.2	2.4	5.0	7.1	11.2	14.3	19.8	31.0	44.5	60.7	79.3	100.4	123.9
1-1/2	0.2	1.1	2.1	4.3	6.2	9.7	12.5	17.3	27.1	39.0	53.0	69.3	87.7	108.2
2	0.1	0.9	1.7	3.5	5.0	7.8	10.0	13.9	21.6	31.2	42.4	55.4	70.1	86.6
2-1/2	0.1	0.7	1.4	2.9	4.1	6.4	8.3	11.4	17.9	25.8	35.1	45.8	57.9	71.5
3	0.1	0.6	1.2	2.4	3.4	5.3	6.8	9.4	14.7	21.2	28.8	37.6	47.6	58.8

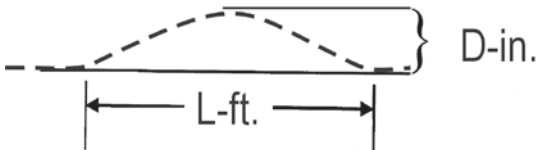

BACKFILLING

CAUTION - Underground pipe must be thoroughly inspected and tested for leaks prior to backfilling (refer to section on hydrostatic pressure testing). Failure to follow this instruction could result in system failure.

During periods of hot weather, backfilling should only be done early in the morning when the line is fully contracted, and there is no chance of insufficiently dried joints being subjected to contraction stresses.

The pipe should be uniformly and continuously supported over its entire length on a firm, stable material. Blocking should not be used to change pipe grade or to intermittently support pipe across excavated sections.

Pipe is installed in a wide range of sub-soils. These soils must be stable and applied in such a manner to physically shield the pipe from damage. Attention should be given to local pipe laying experience, which may indicate particular pipe bedding problems.

Backfill materials that are free of rocks with a particle size of 1/2-inch or less should be used to surround the pipe with 6 to 8 inches of cover. It should be placed in layers. Each soil layer should be sufficiently

compacted to uniformly develop lateral passive soil forces during the backfill operation. It may be advisable to have the pipe under pressure, 15 to 25 psi, during the backfilling.

Vibratory methods are preferred when compacting sand or gravels. Best results are obtained when the soils are in a nearly saturated condition. Where water-flooding is used, the initial backfill should be sufficient to ensure complete coverage of the pipe. Additional material should not be added until the water flooded backfill is firm enough to walk on. Care should be taken to avoid floating the pipe.

Sand and gravel containing a significant proportion of fine-grained material, such as silt and clay should be compacted by hand or, preferably, by mechanical tamper.

The remainder of the backfill should be spread in uniform layers to fill the trench completely so that there will be no unfilled spaces around rocks or lumps of earth in the backfill. Large or sharp rocks, frozen clods, and other debris, greater than 3 inches in diameter, should be removed. Rolling equipment or heavy tampers should be used only to consolidate the final backfill.

Maintenance shall be in accordance with the Standard for Inspection, Testing and

Maintenance of Water Based Extinguishing Systems, as defined by NFPA 25.

Material Properties

**Table I
Modulus of Elasticity & Stress vs. Temperature
For Spears® FlameGuard®™ CPVC Fire Sprinkler Pipe**

Property	Temperature ° F							
	73	80	90	100	110	120	140	150
Modulus of Elasticity "E" x 10 ⁵ psi	3.90	3.84	3.78	3.70	3.46	3.21	3.05	2.84
Working Stress "S" psi	1,900	1,785	1,630	1,485	1,345	1,270	950	875

**Table II
Physical & Thermal Properties**

Property		A-Spears® FlameGuard® CPVC Pipe	ASTM
Specific Gravity	"Sp. Gr."	1.51	D 92
IZOD Impact Strength (ft. lbs/inch of notch)		5.0	D 256A
Modulus of Elasticity, psi	"E"	3.9 x 10 ⁵	D 638
Ultimate Tensile Strength, psi		8,000	D 638
Compressive Strength, psi		9,000	D 695
Poisson's Ratio		.35 - .38	-
Working Stress @ 73° F, psi		1,900	D 1598
Hazen-Williams "C" Factor		150	-
Coefficient of Linear Expansion in./in. ° F)	"e"	3.2 x 10 ⁻⁵	D 696
Thermal Conductivity BTU/(hr ° F Win')	"k"	0.95	C 177
Upper Temperature Limit	"° F"	205	-
Flammability		Flame Retardant	
Electrical Conductivity		Non Conductor	

Expansion and Contraction

Spears® FlameGuard® CPVC Fire Sprinkler Products, like all piping materials, expand and contract with changes in temperature. If the coefficient of linear expansion is 3.2 x10-5 inch/inch ° F. A 25° F change in temperature will cause an expansion of 1 inch for a 100-foot straight length. For most operating and installation conditions, expansion and contraction can be accommodated at changes of direction.

Table III
Thermal Expansion in Inches
For Spears® FlameGuard® CPVC Fire Sprinkler Pipe

Temp. Change ΔT ° F	Length of Run in Feet													
	5	10	15	20	25	30	35	40	45	50	70	90	120	160
	Thermal Expansion ΔL (in.)													
20	0.04	0.08	0.12	0.15	0.19	0.23	0.27	0.31	0.35	0.38	0.54	0.69	0.92	1.23
30	0.06	0.12	0.17	0.23	0.29	0.35	0.40	0.46	0.52	0.58	0.81	1.04	1.38	1.84
40	0.08	0.15	0.23	0.31	0.38	0.46	0.54	0.61	0.69	0.77	1.08	1.38	1.84	2.46
50	0.10	0.19	0.29	0.38	0.48	0.58	0.67	0.77	0.86	0.96	1.34	1.73	2.30	3.07
60	0.12	0.23	0.35	0.46	0.58	0.69	0.81	0.92	1.04	1.15	1.61	2.07	2.76	3.69
70	0.13	0.27	0.40	0.54	0.67	0.81	0.94	1.08	1.21	1.34	1.88	2.42	3.23	4.30
80	0.15	0.31	0.46	0.61	0.77	0.92	1.08	1.23	1.38	1.54	2.15	2.76	3.69	4.92
90	0.17	0.35	0.52	0.69	0.86	1.04	1.21	1.38	1.56	1.73	2.42	3.11	4.15	5.53
100	0.19	0.38	0.58	0.77	0.96	1.15	1.34	1.54	1.73	1.92	2.69	3.46	4.61	6.14

$$\Delta L = 12 eL (\Delta T)$$

$e = 3.2 \times 10^{-5}$ in./in. ° F (Coefficient of Linear Expansion for Spears® FlameGuard® CPVC Fire Sprinkler Pipe) L = Length of Run in Feet

$\Delta T =$ Temperature Change in ° F

Example:

How much will a 40 ft. run of 2" Spears® FlameGuard® CPVC Fire Sprinkler Pipe expand if the expected ambient temperature will range from 45° F to 85° F?

$$\Delta L = 12 eL (\Delta T)$$

$$\Delta L = 12 (.000032) \times 40 \times 40$$

$$\Delta L = .61''$$

Expansion Loop & Offset Configurations

Hangers or guides should only be placed in the loop, offset or change of direction as indicated below. Piping supports should restrict lateral movement and should direct axial movement into the expansion loop.

Expansion Loop and Offset Configurations

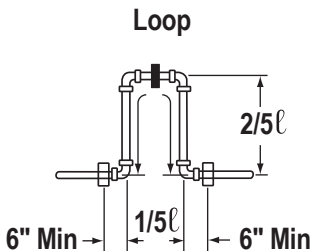

Offset

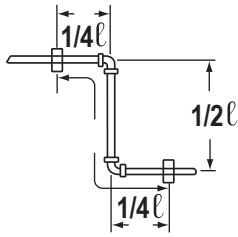

Change of Direction

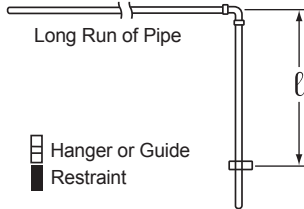

Table IV
Expansion Loop Length in Inches
For Spears® FlameGuard® CPVC Fire Sprinkler Pipe

Nominal Pipe Size	Avg. O.D.	Length of Run in Feet													
		5	10	15	20	25	30	35	40	45	50	70	90	120	160
		Length of Loop (in.) Temperature = 100° F - 30° F, ΔT = 70° F													
3/4	1.050	7	10	13	15	16	18	19	21	22	23	27	31	36	41
1	1.315	8	11	14	16	18	20	22	23	24	26	30	34	40	46
1-1/4	1.660	9	13	16	18	20	22	24	26	27	29	34	39	45	52
1-1/2	1.900	10	14	17	20	22	24	26	28	29	31	37	41	48	55
2	2.375	11	15	19	22	24	27	29	31	33	35	41	46	54	62
2-1/2	2.875	12	17	21	24	27	30	32	34	36	38	45	51	59	68
3	3.500	13	19	23	27	30	33	35	38	40	42	50	56	65	75

Note: Table IV is based on Stress & Modulus Elasticity at 100° F

$$I = \sqrt{\frac{3ED\Delta L}{2S}}$$

I = Length of Expansion Loop in Inches

E = Modulus of Elasticity (Table I)

D = Average O.D. of Pipe

ΔL = Change in Length of Pipe Due to Change in Temperature (Table III)

S = Working Stress (Table I)

Example: How much expansion can be expected in a 200 ft. run of 2" Spears® FlameGuard® CPVC Fire Sprinkler Pipe and how long should the expansion loop be to compensate for this expansion? (The expected temperature range will be from 40° F to 110° F).

First Find:

ΔT = (Change in Temperature)

ΔT = $T_2 - T_1$

ΔT = 110° F - 40° F

ΔT = 70° F

To Find:

ΔL = (Amount of Expansion in inches from Table III)

ΔL = ΔL of 160 ft. with a ΔT of 70° F + ΔL of 40 ft. with a ΔT of 70° F

ΔL = 4.30" + 1.08"

ΔL = 5.38"

-OR-

ΔL = $12eL(\Delta T)$

e = 3.2×10^{-5} (from Table II)

L = Length of Run in Feet

ΔT = Change in Temperature in ° F

ΔL = $12 \times .000032 \times 200 \times 70$

ΔL = 5.38"

To find the length of the expansion loop or offset in inches:

$$I = \sqrt{\frac{3ED\Delta L}{2S}}$$

I = Length of Expansion Loop in Inches

E = Modulus of Elasticity at 110° F (Table I)

D = Average O.D. of Pipe

ΔL = Change in Length of Pipe Due to Change in Temperature (Table III-A)

S = Working Stress at 110° F (Table I)

$$I = \sqrt{\frac{3ED\Delta L}{2S}}$$

$$I = \sqrt{\frac{3 \times 346,000 \times 2.375 \times 5.38}{2 \times 1345}}$$

$$I = \sqrt{4931}$$

$$I = 70.2"$$

Review – Do's & Don'ts

Do's

- Read the manufacturer's installation instructions.
- Follow recommended safe work practices.
- Make certain that thread sealants, gasket lubricants, or fire stop materials are compatible with CPVC.
- Keep pipe and fittings in original packaging until needed.
- Cover pipe and fittings with an opaque tarp if stored outdoors.
- Follow proper handling procedures.
- Use tools specifically designed for use with plastic pipe and fittings.
- Use the proper solvent cement and follow application instructions.
- Use a drop cloth to protect interior finishes.
- Cut the pipe ends square.
- Deburr and bevel the pipe end with a chamfering tool.
- Rotate the pipe 1/4 turn when bottoming pipe in fitting socket.
- Avoid puddling of cement in fittings and pipe.
- Make certain no solvent cement is on sprinkler head and adapter threads.
- Make certain that solvent cement does not run and plug the sprinkler head orifice.
- Follow the manufacturer's recommended cure times prior to pressure testing.
- Fill lines slowly and bleed the air from the system prior to flushing and pressure testing.
- Support sprinkler head properly to prevent lift up of the head through the ceiling when activated.
- Keep threaded rod within 1/16" of the pipe or use a surge arrestor.
- Install Spears® FlameGuard® CPVC Fire Sprinkler Products in wet systems only.
- Use only factory mixed glycerin and water solutions for freeze protection.
- Allow for movement due to expansion and contraction.
- Renew your Spears® FlameGuard® CPVC Fire Sprinkler Products installation training every two years.

Don'ts

- Do not use edible oils such as Crisco as a gasket lubricant.
- Do not use petroleum or solvent-based sealants, lubricants, or fire stop materials.
- Do not install tape, insulated wire or cable in direct contact with CPVC.
- Do not use any glycol-based solutions as an anti-freeze.
- Do not mix glycerin and water solutions in contaminated containers, only factory pre-mixed glycerin is permitted.
- Do not use solvent cement that exceeds its shelf life or has become discolored or jellied.
- Do not allow solvent cement to plug the sprinkler head orifice.
- Do not connect rigid metal couplers to CPVC grooved adapters.
- Do not thread, groove, or drill CPVC pipe.
- Do not use solvent cement near sources of heat, open flame, or when smoking.
- Do not perform System Acceptance Testing with air.
- Do not pressure test until recommended cure times are met.
- Do not use ratchet cutters below 50° F.
- Do not use CPVC pipe that has been stored outdoors, unprotected and is faded in color.
- Do not allow threaded rod to come in contact with the pipe.
- Do not install Spears® FlameGuard® CPVC Fire Sprinkler Products in cold weather without allowing for expansion.

GHS LABEL:

Signal Word: Danger	WHMIS CLASSIFICATION: CLASS B, DIVISION 2
Hazard Statements	Precautionary Statements
H225: Highly flammable liquid and vapor	P210: Keep away from heat/sparks/open flames/hot surfaces - No smoking
H319: Causes serious eye irritation	P261: Avoid breathing dust/fume/gas/mist/vapors/spray
H332: Harmful if inhaled	P280: Wear protective gloves/protective clothing/eye protection/face protection
H335: May cause respiratory irritation	P337+P313: Get medical advice/attention
H336: May cause drowsiness or dizziness	P337+P313: Get medical advice/attention
H351: Suspected of causing cancer	P403+P233: Store in a well-ventilated place. keep container tightly closed
EUH019: May form explosive peroxides	P501: Dispose of contents/container in accordance with local regulation

SECTION 3 - COMPOSITION/INFORMATION ON INGREDIENTS

	CAS#	EINECS #	REACH NUMBER	CONCENTRATION % by Weight
Tetrahydrofuran (THF)	109-99-9	203-726-8	05-2116297729-22-0000	30 - 60
Methyl Ethyl Ketone (MEK)	78-93-3	201-159-0	05-2116297728-24-0000	2 - 25
Cyclohexanone	108-94-1	203-631-1	05-2116297718-25-0000	5 - 15
Acetone	67-64-1	200-662-2	05-2116297713-35-0000	1 - 5

All of the constituents of this adhesive product are listed on the TSCA inventory of chemical substances maintained by the US EPA, or are exempt from that listing.

* Indicates this chemical is subject to the reporting requirements of Section 313 of the Emergency Planning and Community Right-to-Know Act of 1986 (40CFR372).

indicates that this chemical is found on Proposition 65's List of chemicals known to the State of California to cause cancer or reproductive toxicity.

SECTION 4 - FIRST AID MEASURES

Contact with eyes: Flush eyes immediately with plenty of water for 15 minutes and seek medical advice immediately.

Skin contact: Remove contaminated clothing and shoes. Wash skin thoroughly with soap and water. If irritation develops, seek medical advice.

Inhalation: Remove to fresh air. If breathing is stopped, give artificial respiration. If breathing is difficult, give oxygen. Seek medical advice.

Ingestion: Rinse mouth with water. Give 1 or 2 glasses of water or milk to dilute. Do not induce vomiting. Seek medical advice immediately.

Likely Routes of Exposure: Inhalation, Eye and Skin Contact

Acute symptoms and effects:

Inhalation: Severe overexposure may result in nausea, dizziness, headache. Can cause drowsiness, irritation of eyes and nasal passages.

Eye Contact: Vapors slightly uncomfortable. Overexposure may result in severe eye injury with corneal or conjunctival inflammation on contact with the liquid.

Skin Contact: Liquid contact may remove natural skin oils resulting in skin irritation. Dermatitis may occur with prolonged contact.

Ingestion: May cause nausea, vomiting, diarrhea and mental sluggishness.

Chronic (long-term) effects: Category 2 Carcinogen

SECTION 5 - FIREFIGHTING MEASURES

Suitable Extinguishing Media: Dry chemical powder, carbon dioxide gas, foam, Halon, water fog.

Unsuitable Extinguishing Media: Water spray or stream

Exposure Hazards: Inhalation and dermal contact.

Combustion Products: Oxides of carbon, hydrogen chloride and smoke.

Protection for Firefighters: Self-contained breathing apparatus or full-face positive pressure airline masks

	HMIS	NFPA	0-Minimal
Health	2	2	1-Slight
Flammability	3	3	2-Moderate
Reactivity	0	0	3-Serious
PPE	B		4-Severe

SECTION 6 - ACCIDENTAL RELEASE MEASURES

Personal precautions:

Keep away from heat, sparks and open flame

Provide sufficient ventilation, use explosion-proof exhaust ventilation equipment or wear suitable respiratory

protective equipment.

Prevent contact with skin or eyes (see section 8).

Environmental Precautions:

Prevent product or liquids contaminated with product from entering sewers, drains, soil or open water course.

Methods for Cleaning up:

Clean up with sand or other inert absorbent material. Transfer to a closable steel vessel.

Materials not to be used for clean up: Aluminum or plastic containers.

SECTION 7 - HANDLING AND STORAGE

Handling: Avoid breathing of vapor, avoid contact with eyes, skin and clothing

Keep away from ignition sources, use only electrically grounded handling equipment and ensure adequate ventilation/fume exhaust hoods.

Do not eat, drink or smoke while handling.

Storage: Store in ventilated room or shade below 33 °C (90 °F) and away from direct sunlight.

Keep away from ignition sources and incompatible materials: caustics, ammonia, inorganic acids, chlorinated compounds, strong oxidizers and isocyanates.

Follow all precautionary information on container label, product bulletins and solvent cementing literature.

SECTION 8 - PRECAUTIONS TO CONTROL EXPOSURE / PERSONAL PROTECTION

EXPOSURE LIMITS

Component	ACGIH TLV	ACGIH STEL	OSHA PEL	OSHA STEL
Tetrahydrofuran (THF)	50 ppm	100 ppm	200 ppm	N/E
Methyl Ethyl Ketone (MEK)	200 ppm	300 ppm	200 ppm	N/E
Cyclohexanone	20 ppm	50 ppm	50 ppm	N/E
Acetone	500 ppm	750 ppm	1000 ppm	N/E

Component	OSHA PEL-Ceiling	CAL/OSHA PEL	CAL/OSHA Ceiling	CAL/OSHA STEL
Tetrahydrofuran (THF)	N/E	200 ppm	N/E	250 ppm
Methyl Ethyl Ketone (MEK)	N/E	200 ppm	N/E	300 ppm
Cyclohexanone	N/E	25 ppm	N/E	N/E
Acetone	N/E	500 ppm	3000 ppm	750 ppm

Engineering Controls: Use local exhaust as needed.

Monitoring: Maintain breathing zone airborne concentrations below exposure limits.

Personal Protective Equipment (PPE):

Eye Protection: Avoid contact with eyes, wear splash-proof chemical goggles, face shield, safety glasses (spectacles) with brow guards and side shields, etc. as may be appropriate for the exposure.

Skin Protection:

Prevent contact with the skin as much as possible. Butyl rubber gloves should be used for frequent immersion. Use of solvent-resistant gloves or solvent-resistant barrier cream should provide adequate protection when normal adhesive application practices and procedures are used for making structural bonds.

Respiratory Protection: Prevent inhalation of the solvents. Use in a well-ventilated room. Open doors and/or windows to ensure airflow and air changes. Use local exhaust ventilation to remove airborne contaminants from employee breathing zone and to keep contaminants below levels listed above. With normal use, the Exposure Limit Value will not usually be reached. When limits approach, use respiratory protection equipment

SECTION 9 - PHYSICAL AND CHEMICAL PROPERTIES

Appearance: Red, heavy syrupy liquid

Odor: Ether-Like **Odor Threshold:** 0.88 ppm (Cyclohexanone)

pH: Not Applicable

Melting/Freezing Point: -108.5 °C (-163.3 °F) Based on first melting component: THF

Boiling Point: 66 °C (151 °F) Based on first boiling component: THF

Boiling Range: 66°C (151°F) to 156°C (313°F)

Flash Point: -20 °C (-4 °F) TCC based on THF

Specific Gravity: 0.857 ± 0.01 @ 23°C ± 2° (73°F ± 3.6°)

Solubility: Solvent portion soluble in water. Resin portion separates out.

Partition Coefficient n-octanol/water: Not Available

Auto-ignition Temperature: 321 °C (610 °F) based on THF

Decomposition Temperature: Not Applicable

VOC Content: When applied as directed, per SCAQMD Rule 1168, Test Method 316A, VOC content is: < 490 g/l.

Evaporation Rate: > 1.0 (BUAC = 1)

Flammability: Category 2

Flammability Limits: LEL: 1.1% based on Cyclohexanone

UEL: 11.8% based on THF

Vapor Pressure: 129 mm Hg @ 20 °C (68 °F) based on THF

Vapor Density: >2.0 (Air = 1)

Other Data: Viscosity: Heavy bodied

SECTION 10 - STABILITY AND REACTIVITY

Stability: Stable

Hazardous decomposition products: None in normal use. When forced to burn, this product gives off oxides of carbon, hydrogen chloride and smoke.

Conditions to avoid: Keep away from heat, sparks, open flame and other ignition sources.

Incompatible Materials: Oxidizers, strong acids and bases, amines, ammonia

SECTION 11 - TOXICOLOGICAL INFORMATION

Toxicity:	LD50	LC50
Tetrahydrofuran (THF)	Oral: 2842 mg/kg (rat)	Inhalation 3 hrs. 21,000 mg/m ³ (rat)
Methyl Ethyl Ketone (MEK)	Oral: 2737 mg/kg (rat), Dermal: 6480 mg/kg (rabbit)	Inhalation 8 hrs. 23,500 mg/m ³ (rat)
Cyclohexanone	Oral 1535 mg/kg (rat), Dermal: 948 mg/kg (rabbit)	Inhalation 4 hrs. 8,000 PPM (rat)
Acetone	Oral: 5800 mg/kg (rat)	Inhalation 50,100 mg/m ³ (rat)

Toxicity: Target Organs

Tetrahydrofuran (THF) STOT SE3

Methyl Ethyl Ketone (MEK) STOT SE3

Cyclohexanone

Acetone STOT SE3

Reproductive Effects Teratogenicity Mutagenicity

Not Establish Not Established Not Established

Embryotoxicity Sensitization to Product Synergistic Products

Not Established Not Established Not Established

SECTION 12 - ECOLOGICAL INFORMATION

Ecotoxicity: None Known

Mobility: In normal use, emission of volatile organic compounds (VOC's) to the air takes place, typically at a rate of < 490g/l.

Degradability: Biodegradable

Bioaccumulation: Minimal to none

SECTION 13 - WASTE DISPOSAL CONSIDERATIONS

Follow local and national regulations. Consult disposal expert

SECTION 14 - TRANSPORT INFORMATION

Proper Shipping Name: Adhesives

Hazard Class: 3

Secondary Risk: None

Identification Number: UN 1133

Packing Group: PG II

Label Required: Class 3 Flammable Liquid

Marine Pollutant: NO

EXCEPTION for Ground Shipping

DOT Limited Quantity: Up to 1L per inner packaging, 30 kg gross weight per package.

Consumer Commodity: Depending on packaging, these quantities may qualify under DOT as "ORM-D"

TDG INFORMATION

TDG CLASS: FLAMMABLE LIQUID 3

SHIPPING NAME: ADHESIVES

UN NUMBER/PACKING GROUP: UN 1133, PG II

SECTION 15 - REGULATORY INFORMATION

Precautionary Label Information: Highly Flammable, Irritant

Symbols: F, Xi

Risk Phrases: R11: Highly flammable; R36/37: Irritating to eyes and respiratory system; R66: Repeated exposure may cause skin dryness or cracking; R67: Vapors may cause drowsiness and dizziness

Safety Phrases: S2: Keep out of the reach of children; S9: Keep container in a well-ventilated place; S16: Keep away from sources of ignition - No smoking; S25: Avoid contact with eyes; S26: In case of contact with eyes, rinse immediately with plenty of water and seek medical advice; S33: Take precautionary measures against static discharges.

Ingredient Listings: USA TSCA, Europe EINECS, Canada DSL, Australia AICS, Korea ECL/TCCL, Japan MITI (ENCS)

SECTION 16 - OTHER INFORMATION

Specification Information:

Department issuing data sheet: Environmental Health & Safety
All ingredients are compliant with the requirements of the European Directive on RoHS (Restriction of Hazardous Substances).

E-mail address: EHSInfo@SpearsMfg.net

Training necessary: Yes, training in practices and procedures contained in product literature.

Reissue date / reason for reissue: 09/01/15 / Updated GHS Standard Format

Intended Use of Product: Solvent Cement for CPVC Plastic Pipe

This product is intended for use by skilled individuals at their own risk. The information contained herein is based on data considered accurate based on current state of knowledge and experience. However, no warranty is expressed or implied regarding the accuracy of this data or the results to be obtained from the use thereof.



TorqueSafe™ Gasket Sealed Head Adapter

No Thread Sealant to be Used
Hand Tight + 10 to 25 ft-lbs Torque to Rotate for Sprinkler Head Alignment

QuickTorque™ & SoftTorque™

Gasket Sealed Head Adapter
No Thread Sealant to be Used
Finger Tight + 1-Turn, Up to 1-Additional Turn to Align Head



For Other Thread Connections:

1. Use a compatible paste sealant. Spears® recommends [BLUE 75™](#), tested for compatibility with CPVC products.
2. Apply sealant to male threads.
3. Install Sprinkler Heads or make metal pipe transitions, tighten as follows:



Adapter for
Metal Pipe
Transition



Hand tight
+1.5 to 2
Turns

SR Plastic
Thread



Min. 5 ft-lbs
Max. 10 ft-lbs
Torque

Metal
Thread



Min. 15 ft-lbs
Max. 20 ft-lbs
Torque

If You Feel You MUST Use Tape Sealant . . .

... DO IT CORRECTLY!

Failure to follow instructions can result in thread breaks from too much tape, difficult assembly from not enough, or leaks due to exposed starting threads.

DO NOT USE TAPE & PASTE!

- DO NOT USE with Gasket Sealed Head Adapters
- USE a TFE tape with a min. thickness of 3.5 mil.
- Cover male starting threads to prevent seizing.



- Wrap tape in direction of threads.
 - For Regular Head Adapters, use 2 to 3 wraps. Tighten to specified torque (see front cover).
 - For Female Adapter Transitions to metal pipe, use ONLY 5 to 5-1/2 wraps.
- Joint Assembly — tighten 1-2 turns beyond finger tight. DO NOT back up. DO NOT over tighten!

SPEARS® MANUFACTURING COMPANY
15853 Olden Street , Sylmar CA 91342
PO Box 9203, Sylmar, CA 91392
(818) 364-1611
www.spearsmfg.com



SPEARS® MANUFACTURING COMPANY CORPORATE OFFICE

15853 Olden St., Sylmar, CA 91342
PO Box 9203, Sylmar, CA 91392
(818) 364-1611 • www.spearsmfg.com

PACIFIC SOUTHWEST

Sylmar (Los Angeles), CA 91342
(818) 364-1611 • (800) 862-1499
Stockton, CA 95206
(818) 364-1611 • (800) 862-1499

ROCKY MOUNTAIN

Denver, CO 80238
(303) 371-9430 • (800) 777-4154

NORTHEAST

Lewisberry (Harrisburg), PA 17339
(717) 938-8844 • (800) 233-0275
Philadelphia, PA 19116
(717) 938-8844 • (800) 233-0275
Mansfield, MA 02048
(717) 938-8844 • (800) 233-0275

MIDWEST

Bolingbrook (Chicago), IL 60440
(630) 759-7529 • (800) 662-6330
Louisville, KY 40214
(630) 759-7529 • (800) 662-6330
Dayton, MN 55369
(630) 759-7529 • (800) 662-6330

NORTHWEST

Auburn (Seattle), WA 98002
(253) 939-4433 • (800) 347-7327

UTAH

Salt Lake City, UT 84104
(303) 371-9430 • (800) 777-4154

SOUTH CENTRAL

Flower Mound, TX 75028
(469) 528-3000 • (800) 441-1437
Houston, TX 77092
(469) 528-3000 • (800) 441-1437

FLORIDA

Orlando, FL 32837
(407) 843-1960 • (800) 327-6390

SOUTHEAST

Lawrenceville (Atlanta), GA 30043
(678) 985-1263 • (800) 662-6326

INTERNATIONAL SALES

15853 Olden St.
Sylmar (Los Angeles), CA 91342
(818) 364-1611 • Fax (818) 898-3774



Standard Interpretations - Table of Contents

• **Standard Number:** [1910.146](#); [1910.146\(b\)](#); [1910.146\(c\)\(7\)](#); [1910.147](#)

OSHA requirements are set by statute, standards and regulations. Our interpretation letters explain these requirements and how they apply to particular circumstances, but they cannot create additional employer obligations. This letter constitutes OSHA's interpretation of the requirements discussed. Note that our enforcement guidance may be affected by changes to OSHA rules. Also, from time to time we update our guidance in response to new information. To keep apprised of such developments, you can consult OSHA's website at <http://www.osha.gov>.

October 27, 1995

Mr. Edward A. Donoghue ~~Associates Inc.~~
[Donoghue Associates Inc.]
Code and Safety Consultant to NEII
Shushan Road, P.O. Box 201
Salem, NY 12865-0201

Dear Mr. Donoghue:

This is in further response to your letter of January 27, and the joint meeting of June 20, between National Elevator Industry Inc. (NEII) and the Occupational Safety and Health Administration (OSHA) requesting guidance in determining whether elevator pits meet the definition of confined spaces. We would like to thank the NEII members for your frank discussion and for conveying the difficulties you face in your industry.

After listening to the presentation restating NEII's position and explanation of the underlying rationale for its position, OSHA believes:

1. The need for a ladder to exit an elevator pit means that there is a restricted means of entry and exit; (Please note: deep elevator pits that have a standard door entry at the base of the pit would not be considered to be restrictive to entry or exit.)
2. Most elevator pits are not designed for continuous human occupancy since they generally cannot be occupied during normal elevator operation.

The third element of the confined space definition (large enough to enter and do work) was not at issue. Thus, with all the definition's elements met, our answer to the question of whether elevator pits are to be considered confined spaces continues to be, generally yes.

However, being classified as a confined space does not automatically mean that elevator pits are Permit-Required Confined Spaces. In order for a confined spaces to be classified as a "Permit space" an acute hazard must be potentially or actually present within the space at the time of entry.

During the meeting the members asserted that as to the vast majority (estimated to be 99%) of the nation's 700,000 elevators:

1. They are in commercial and residential buildings (with the remainder being in industrial settings). Therefore, potential acute atmospheric hazards in the pits are rare because most of the elevators are in the public areas of commercial buildings and share the ambient air of these areas. As such, the chance for the development of a toxic atmospheric condition usually remote and does not generally need to be addressed beyond the initial evaluation and determination of the space.
2. The predominant hazards (mechanical and electrical) stem from elevator-related equipment. Consequently, while most pits may not contain a potential atmospheric hazard, elevator pits generally are permit-required confined spaces by virtue of the electrical-mechanical hazard(s). Where the electrical-mechanical hazard(s) can be eliminated, and where there are no potential or actual atmospheric or other hazards, the pit can be [re-classified] and rendered non-permit required spaces by employing the procedures specified in paragraph 1910.146(c)(7). [It is possible, in some cases, to de-energize and lockout/tagout the elevator equipment using the energy control procedures specified in 1910.147 so that the associated energy hazards are eliminated.] It is our understanding that the pit stop switch would not **lock-out [isolate]** the elevator since it is not a main electrical energy disconnect; the main disconnect to elevator equipment would have to be used and locked or tagged to accomplish an electrical de-energization.

[However, if elimination of the hazards require entry into the pit, or if entry into the pit is necessary to verify that the hazards have been eliminated (such as using a test instrument to verify electrical circuit de-energization pursuant to 1910.333) the permit-required confined space entry procedures would need to be followed until the hazards are eliminated.] Reclassification can be accomplished by either the host employer or the entry (contractor) employer.

As noted in the standard, using ventilation to preclude the possibility of a hazardous atmosphere is considered control of the atmospheric hazard and is not considered elimination. If any of the hazards that originally triggered the classification of the space as a permit space reappear, or a new hazard is introduced into the non-permit space, entry operations under (c)(7) must stop and the space must revert to a permit space. To continue to employ paragraph (c)(7), all hazards must be eliminated.

Elevator service and repair companies must coordinate with the host employer with respect to the initial evaluation of the pit space for compliance with the PRCS standard. This will include obtaining from the host employer the necessary hazard information to allow the elevator company to evaluate or reevaluate the pit space. To that end, a restating of the "host employer" obligations to contractors who work at their facilities is in order as it was an issue during our discussions.

Besides the initial determination requirement of paragraph (c)(1), the "host" employer must comply with the five (5) requirements of paragraph (c)(8) when engaging another employer (contractor) who will have employees in permit spaces under the control of the host employer.

These 29 CFR 1910.146(c)(8) requirements are:

- i. Inform the contractor that the workplace contains permit spaces and that permit space entry is allowed only through compliance with a permit space program meeting requirements of paragraph (d) of 1910.146.
- ii. **Apprise the contractor of the elements, including the hazards identified and the host employer's experience with the space, that make the space in question a permit space.**
- iii. Apprise the contractor of any precautions or procedures that the host employer has implemented for the protection of employees in or near permit spaces where contractor personnel will be working.
- iv. Coordinate entry operations with the contractor, when both host employer personnel and contractor personnel will be working in or near permit spaces, as required by paragraph (d)(11) of the PRCS standard.
- v. Debrief the contractor at the conclusion of the entry operations regarding the permit space program followed and regarding any hazards confronted or created in permit spaces during entry operations.

A host employer, when appraising a contractor of the potential hazards of a specific space, must sufficiently identify each of the potential hazards anticipated in the space under consideration based on the work environment where the space resides. **A bare statement that a hazardous atmosphere is or is believed to be present in the elevator pit area does not meet OSHA's intent for communication of hazard with regard to the 29 CFR 1910.146(c)(8)(ii).**

In our meeting, you referred to standard industry entry practices and training associated with pit entry (Lockout/Tagout, Hazcom, etc.) established in the NEII developed "Field Employee Safety Handbook." You also stated that the vast majority of pit entries are accomplished by one employee who, with respect to 1910.146(c)(7)(iii), would be the evaluator, certifier, and entrant. Since the purpose of the certification is to document that the hazards have been eliminated and identify the person making the determination for entrants, it appears that employees who were adequately trained to do the 1910.146(c)(7)(iii) evaluation would not need to document that the hazards were eliminated if the only employee working at the site is the one doing the (c)(7) determination.

In summary:

1. OSHA continues to view elevator pits generally as confined spaces;
2. There has to be a potential or actual hazard present in the elevator pit in order for it to be classified as a permit-required confined space. Most elevator pits contain at least mechanical and electrical hazards.
3. If all the hazards in the elevator pit can be eliminated [prior to entry], the pit can be reclassified as a non-permit space.
4. Host employers must provide contractors with the specific hazard information on which the permit space-determination is based.

As before, a copy of this letter will be provided to all our Regional Administrators for further distribution within Federal OSHA community and also to our State Plan stakeholder.

Should you have questions on this response, please contact [OSHA's Office of General Industry Enforcement (202)693-1850].

Sincerely,

John B. Miles, Jr., Director
Directorate of Compliance Programs

[This document was edited March 2008 to reflect policy contained in OSHA instruction [CPL 02-00-147](#)]

Corrected: 07/11/2012

[Freedom of Information Act](#) | [Privacy & Security Statement](#) | [Disclaimers](#) | [Important Web Site Notices](#) | [International](#) | [Contact Us](#)

U.S. Department of Labor | Occupational Safety & Health Administration | 200 Constitution Ave., NW, Washington, DC 20210
Telephone: 800-321-OSHA (6742) | TTY: 877-889-5627
www.OSHA.gov

A Guide to Safety in Confined Spaces

by

Ted Pettit and Herb Linn

This document can be taken into CSA exams as long as it is bound.

U.S. DEPARTMENT OF HEALTH AND HUMAN SERVICES
Public Health Service
Centers for Disease Control
National Institute for Occupational Safety and Health

July 1987

For sale by the Superintendent of Documents, Congressional Sales Office
U.S. Government Printing Office, Washington, DC 20402

What is NIOSH?

The National Institute for Occupational Safety and Health (NIOSH) was formed in 1971 to conduct research, develop educational and training resources, and develop criteria for recommended standards in the area of occupational safety and health. NIOSH is part of the Centers for Disease Control (CDC), and the Public Health Service under the Department of Health and Human Services in the executive branch of the U.S. Federal Government.

NIOSH employs about 850 administrators, scientists, engineers, technicians, and support staff at its headquarters in Atlanta, Georgia, and its laboratories and offices in Cincinnati, Ohio and Morgantown, West Virginia.

This guide was developed by the NIOSH Division of Safety Research in Morgantown, West Virginia.

INTRODUCTION

If you are required to construct or work in a:

BOILER, CUPOLA, DEGREASER, FURNACE, PIPELINE, PIT, PUMPING STATION, REACTION OR PROCESS VESSEL, SEPTIC TANK, SEWAGE DIGESTER, SEWER, SILO, STORAGE TANK, SHIP'S HOLD, UTILITY VAULT, VAT, or similar type enclosure,

you are working in a confined space (See examples on page 3).

How Can You Identify a Confined Space?

A confined space is a space which has any one of the following characteristics:

- limited openings for entry and exit
- unfavorable natural ventilation
- not designed for continuous worker occupancy.

Limited openings for entry and exit:

Confined space openings are limited primarily by size or location. Openings are usually small in size, perhaps as small as 18 inches in diameter, and are difficult to move through easily. Small openings may make it very difficult to get needed equipment in or out of the spaces, especially protective equipment such as respirators needed for entry into spaces with hazardous atmospheres, or life-saving equipment when rescue is needed. However, in some cases openings may be very large, for example open-topped spaces such as pits, degreasers, excavations, and ships' holds. Access to open-topped spaces may require the use of ladders, hoists, or other devices, and escape from such areas may be very difficult in emergency situations.

Unfavorable natural ventilation:

Because air may not move in and out of confined spaces freely due to the design, the atmosphere inside a confined space can be very different from the atmosphere outside. Deadly gases may be trapped inside, particularly if the space is used to store or process chemicals or organic substances which may decompose. There may not be enough oxygen inside the confined space to support life, or the air could be so oxygen-rich that it is likely to increase the chance of fire or explosion if a source of ignition is present.

Not designed for continuous worker occupancy:

Most confined spaces are not designed for workers to enter and work in them on a routine basis. They are designed to store a product, enclose materials and processes, or transport products or substances. Therefore, occasional worker entry for inspection, maintenance, repair, cleanup, or similar tasks is often difficult and dangerous due to chemical or physical hazards within the space.

A confined space found in the workplace may have a combination of these three characteristics, which can complicate working in and around these spaces as well as rescue operations during emergencies. If a survey of your working area identifies one or more work spaces with the characteristics listed above,

READ THE FOLLOWING INFORMATION - SOMEDAY IT MAY SAVE YOUR LIFE, OR THE LIFE OF A CO-WORKER.

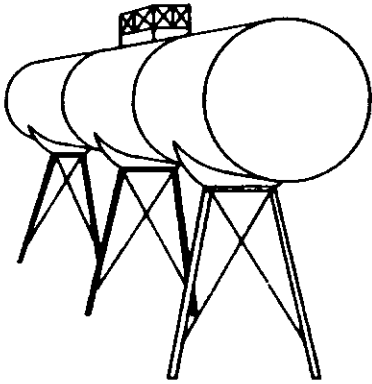

Storage Tank

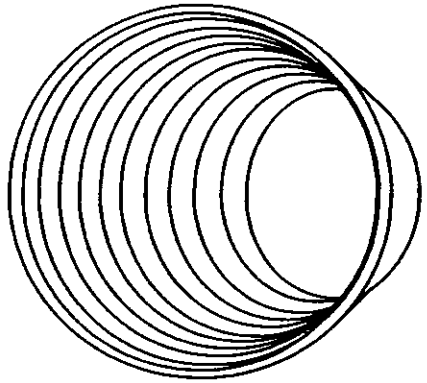

Pipeline

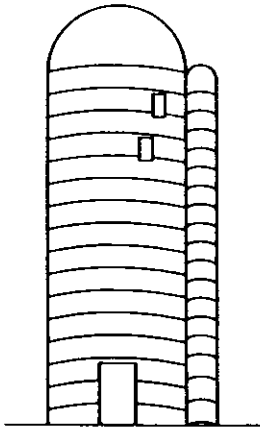

Silo

**Examples of
Confined Spaces**

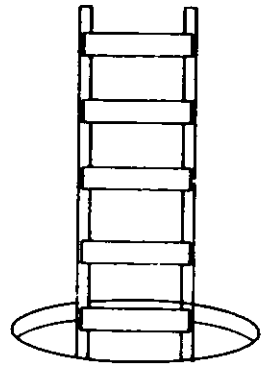
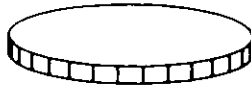

Manhole

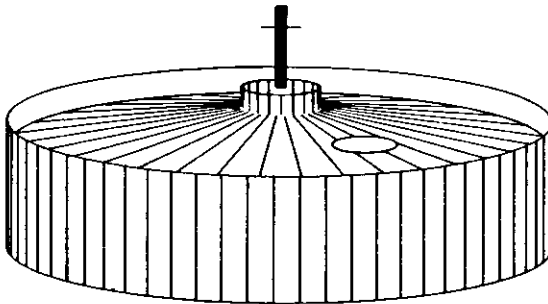

Digester

What are the Hazards Involved in Entering and Working in Confined Spaces?

Hazardous Atmospheres

As mentioned, the atmosphere in a confined space may be extremely hazardous because of the lack of natural air movement. This characteristic of confined spaces can result in 1) oxygen-deficient atmospheres, 2) flammable atmospheres, and/or 3) toxic atmospheres.

1. OXYGEN-DEFICIENT ATMOSPHERES:

An oxygen-deficient atmosphere has less than 19.5% available oxygen (O_2). Any atmosphere with less than 19.5% oxygen should not be entered without an approved self-contained breathing apparatus (SCBA).

The oxygen level in a confined space can decrease because of work being done, such as welding, cutting, or brazing; or, it can be decreased by certain chemical reactions (rusting) or through bacterial action (fermentation).

The oxygen level is also decreased if oxygen is displaced by another gas, such as carbon dioxide or nitrogen. Total displacement of oxygen by another gas, such as carbon dioxide, will result in unconsciousness, followed by death.

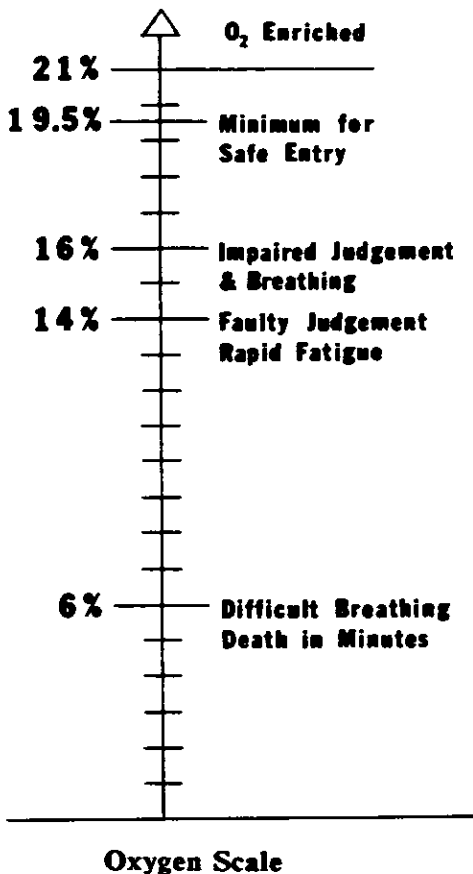

2. FLAMMABLE ATMOSPHERES:

Two things make an atmosphere flammable: 1) the oxygen in air; and 2) a flammable gas, vapor, or dust in the proper mixture. Different gases have different flammable ranges. If a source of ignition (e.g., a sparking or electrical tool) is introduced into a space containing a flammable atmosphere, an explosion will result.

An oxygen-enriched atmosphere (above 21%) will cause flammable materials, such as clothing and hair, to burn violently when ignited. Therefore, never use pure oxygen to ventilate a confined space. Ventilate with normal air.

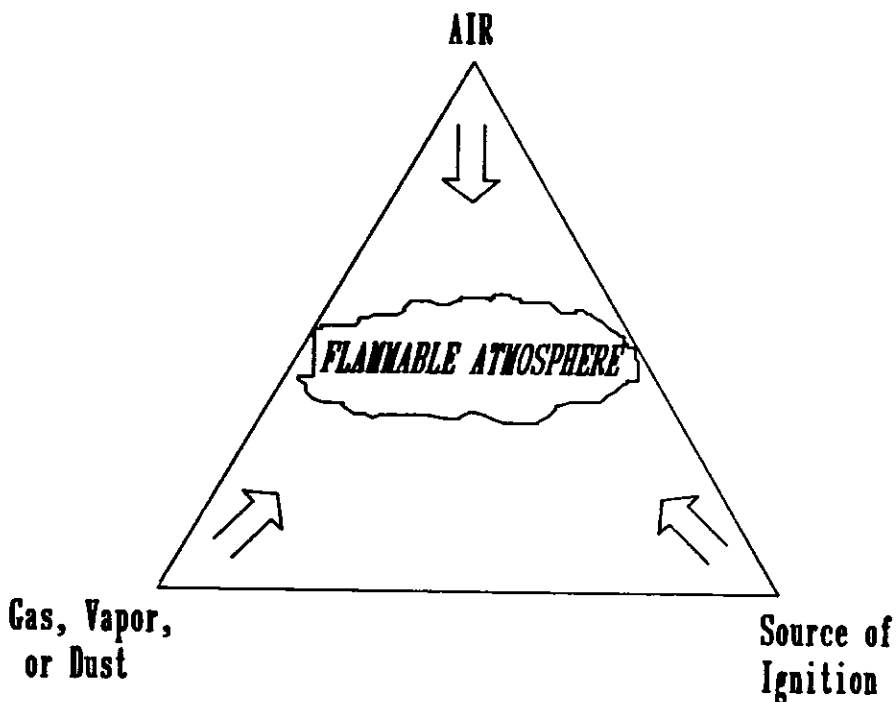

The Ignition Triangle

3. TOXIC ATMOSPHERES:

Most substances (liquids, vapors, gases, mists, solid materials, and dusts) should be considered hazardous in a confined space. Toxic substances can come from the following:

- *The product stored in the space:*

The product can be absorbed into the walls and give off toxic gases when removed or when cleaning out the residue of a stored product, toxic gases can be given off. Example: Removal of sludge from a tank - decomposed material can give off deadly hydrogen sulfide gas.

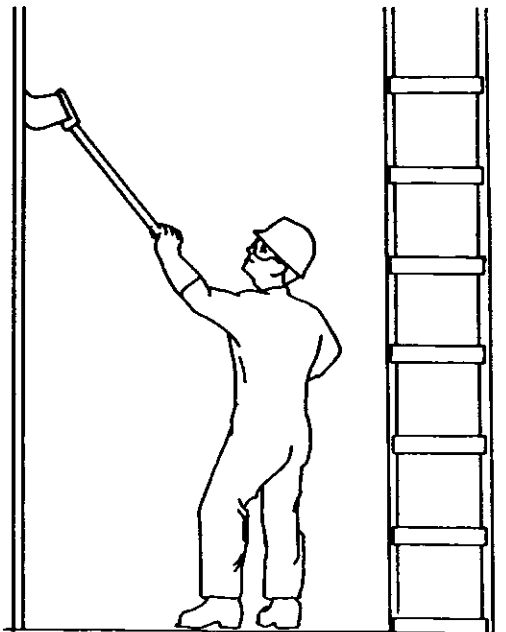

- *The work being performed in a confined space:*

Examples of such include welding, cutting, brazing, painting, scraping, sanding, degreasing, etc. Toxic atmospheres are generated in various processes. For example, cleaning solvents are used in many industries for cleaning/degreasing. The vapors from these solvents are very toxic in a confined space.

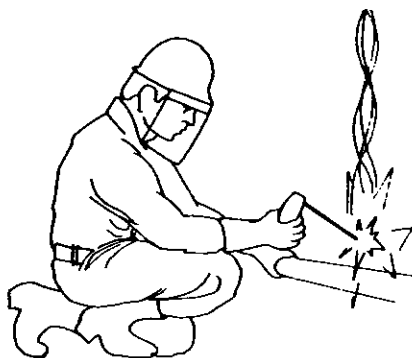

- *Areas adjacent to the confined space:*

Toxicants produced by work in the area of confined spaces can enter and accumulate in confined spaces.

TESTING THE ATMOSPHERE

It is important to understand that some gases or vapors are heavier than air and will settle to the bottom of a confined space. Also, some gases are lighter than air and will be found around the top of the confined space. Therefore, it is necessary to test all areas (top, middle, bottom) of a confined space with properly calibrated testing instruments to determine what gases are present. If testing reveals oxygen-deficiency, or the presence of toxic gases or vapors, the space must be ventilated and re-tested before workers enter. If ventilation is not possible and entry is necessary (for emergency rescue, for example), workers must have appropriate respiratory protection.

NEVER TRUST YOUR SENSES TO DETERMINE IF THE AIR IN A CONFINED SPACE IS SAFE! YOU CAN NOT SEE OR SMELL MANY TOXIC GASES AND VAPORS, NOR CAN YOU DETERMINE THE LEVEL OF OXYGEN PRESENT.

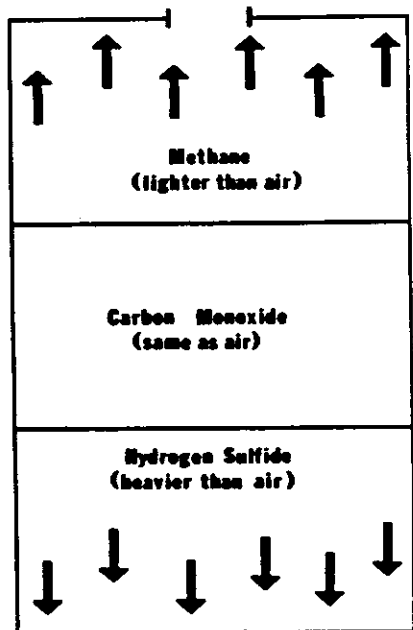

From the Outside, Top to Bottom

VENTILATION

Ventilation by a blower or fan may be necessary to remove harmful gases and vapors from a confined space. There are several methods for ventilating a confined space. The method and equipment chosen are dependent upon the size of the confined space openings, the gases to be exhausted (e.g., are they flammable?), and the source of makeup air.

Under certain conditions where flammable gases or vapors have displaced the oxygen level, but are too rich to burn, forced air ventilation may dilute them until they are within the explosive range. Also, if inert gases (e.g. carbon dioxide, nitrogen, argon) are used in the confined space, the space should be well ventilated and re-tested before a worker may enter.

A common method of ventilation requires a large hose, one end attached to a fan and the other lowered into a manhole or opening. For example, a manhole would have the ventilating hose run to the bottom to blow out all harmful gases and vapors (see diagram). The air intake should be placed in an area that will draw in fresh air only. Ventilation should be continuous where possible, because in many confined spaces the hazardous atmosphere will form again when the flow of air is stopped.

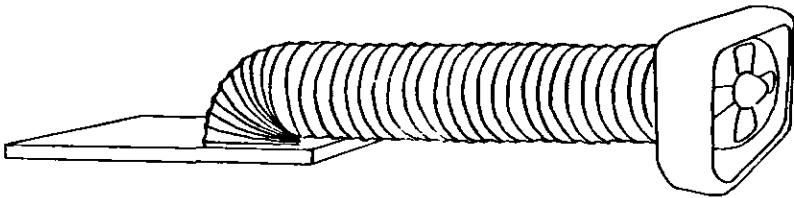

Ventilating with Fan and Trunk Hose

ISOLATION

Isolation of a confined space is a process where the space is removed from service by:

- *locking out*
electrical sources, preferably at disconnect switches remote from the equipment
- *blanking and bleeding*
pneumatic and hydraulic lines
- *disconnecting*
belt and chain drives, and mechanical linkages on shaft-driven equipment where possible, and
- *securing*
mechanical moving parts within confined spaces with latches, chains, chocks, blocks, or other devices.

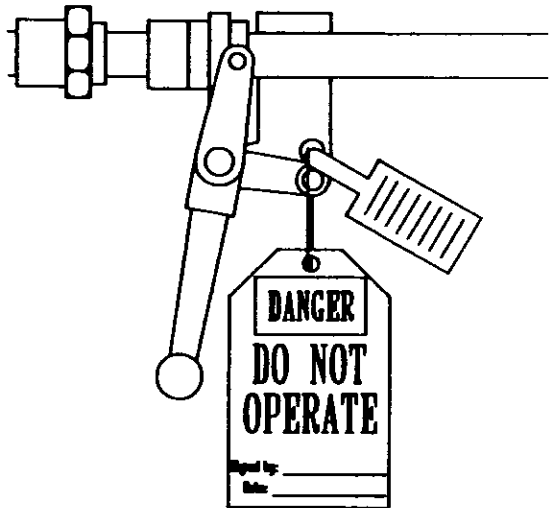
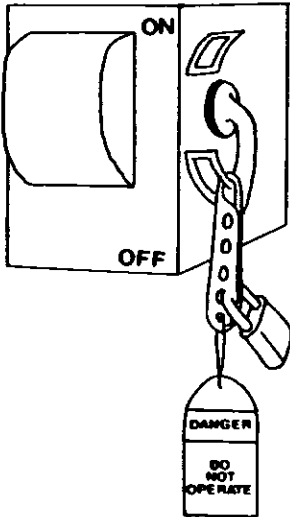

Examples of Lockout

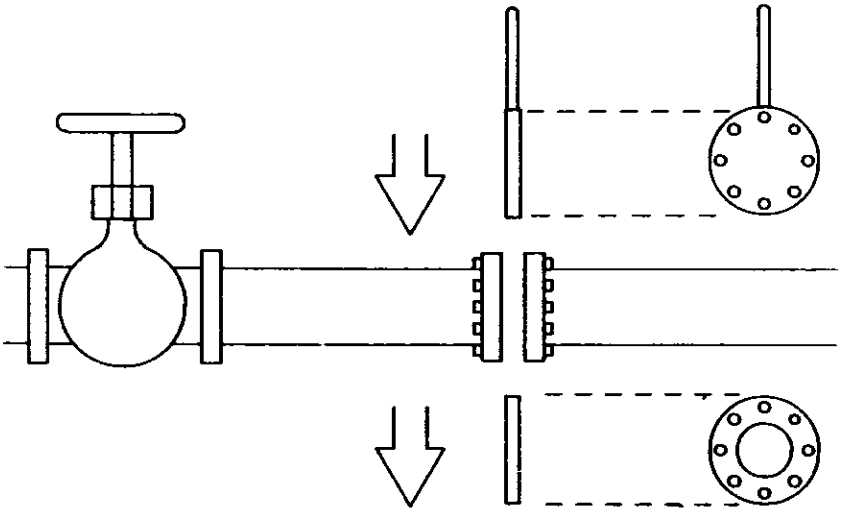

Method of Blanking Hydraulic/Pneumatic Lines

RESPIRATORS

Respirators are devices that can allow workers to safely breathe without inhaling toxic gases or particles. Two basic types are air-purifying, which filter dangerous substances from the air, and air-supplying, which deliver a supply of safe breathing air from a tank or an uncontaminated area nearby.

ONLY AIR-SUPPLYING RESPIRATORS SHOULD BE USED IN CONFINED SPACES WHERE THERE IS NOT ENOUGH OXYGEN.

Selecting the proper respirator for the job, the hazard, and the person is very important, as is thorough training in the use and limitations of respirators. Questions regarding the proper selection and use of respirators should be addressed to a certified industrial hygienist, or to the NIOSH Division of Safety Research, 944 Chestnut Ridge Rd., Morgantown, West Virginia 26505.

Air-Purifying Respirators

(Do Not Use in Oxygen-Deficient Atmosphere)



Half-mask



Full-Facepiece

Air-Supplying Respirators



*Supplied Air Respirator with
Auxiliary, Escape-only SCBA*

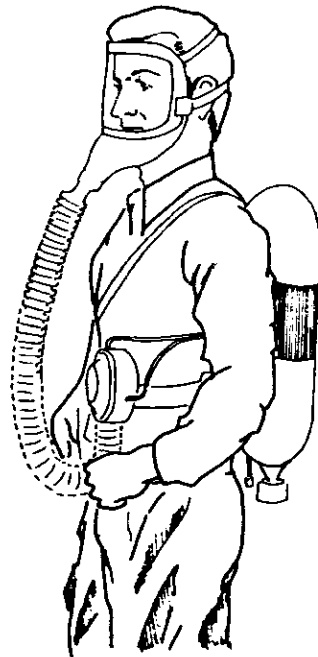

*Self-contained Breathing
Apparatus (SCBA)*

STANDBY/RESCUE

A standby person should be assigned to remain on the outside of the confined space and be in constant contact (visual or speech) with the workers inside. The standby person should not have any other duties but to serve as standby and know who should be notified in case of emergency. Standby personnel should not enter a confined space until help arrives, and then only with proper protective equipment, life lines, and respirators.

Over 50% of the workers who die in confined spaces are attempting to rescue other workers.

Rescuers must be trained in and follow established emergency procedures and use appropriate equipment and techniques (lifelines, respiratory protection, standby persons, etc.). Steps for safe rescue should be included in all confined space entry procedures. Rescue should be well planned and drills should be frequently conducted on emergency procedures. Unplanned rescue, such as when someone instinctively rushes in to help a downed co-worker, can easily result in a double fatality, or even multiple fatalities if there are more than one would-be rescuers.

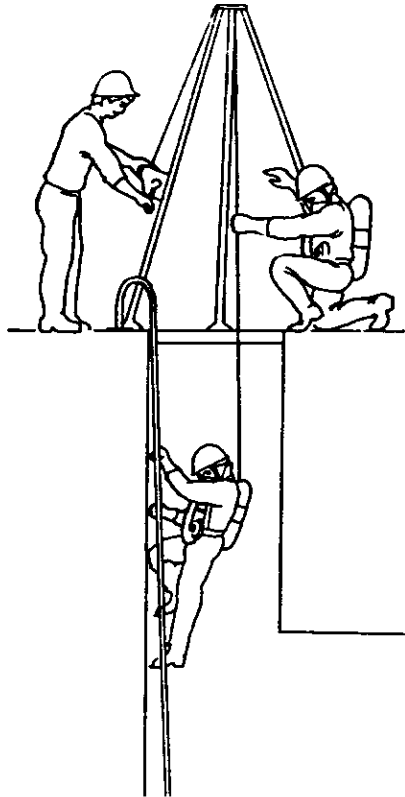

Entry with Hoist and Standby Personnel

REMEMBER: AN UNPLANNED RESCUE WILL PROBABLY BE YOUR LAST .

GENERAL/PHYSICAL HAZARDS

In addition to the areas discussed above, evaluation of a confined space should consider the following potential hazards:

1. TEMPERATURE EXTREMES:

Extremely hot or cold temperatures can present problems for workers. For example, if the space has been steamed, it should be allowed to cool before any entry is made.

2. ENGULFMENT HAZARDS:

Loose, granular material stored in bins and hoppers, such as grain, sand, coal, or similar material, can engulf and suffocate a worker. The loose material can crust or bridge over in a bin and break loose under the weight of a worker.

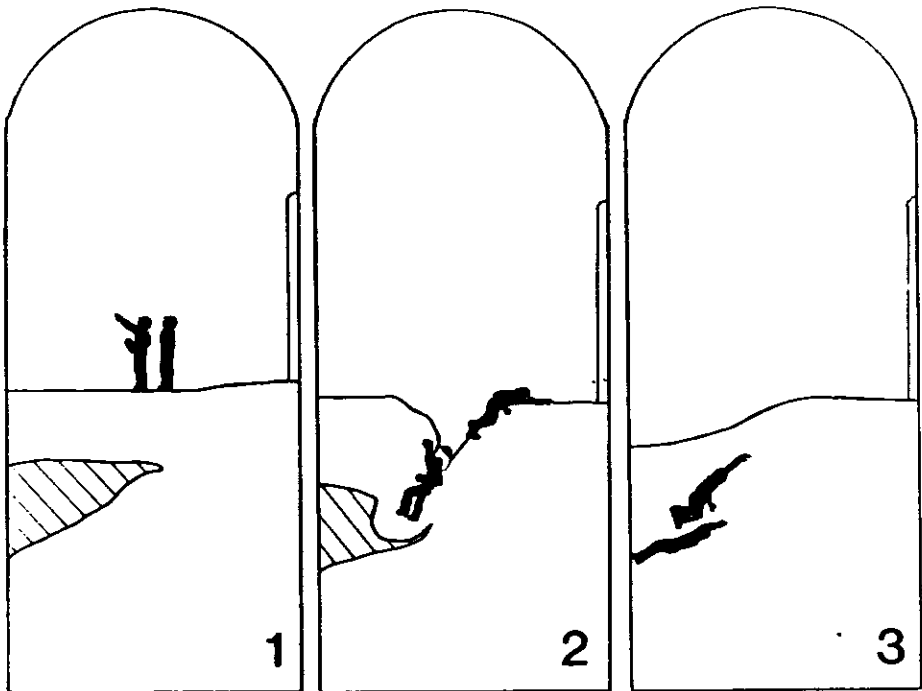

The Hazard of Engulfment in Unstable Material

3. NOISE:

Noise within a confined space can be amplified because of the design and acoustic properties of the space. Excessive noise can not only damage hearing, but can also affect communication, such as causing a shouted warning to go unheard.

4. SLICK/WET SURFACES:

Slips and falls can occur on a wet surface causing injury or death to workers. Also, a wet surface will increase the likelihood for and effect of electric shock in areas where electrical circuits, equipment, and tools are used.

5. FALLING OBJECTS:

Workers in confined spaces should be mindful of the possibility of falling objects, particularly in spaces which have topside openings for entry, and where work is being done above the worker.

RECOMMENDATIONS FOR SAFE ENTRY: A CHECKLIST

Use the following checklist to evaluate the confined space.

DO NOT ENTER A CONFINED SPACE UNTIL YOU HAVE CONSIDERED EVERY QUESTION, AND HAVE DETERMINED THE SPACE TO BE SAFE.

YES NO

Is entry necessary?

TESTING

Are the instruments used in atmospheric testing properly calibrated?

Was the atmosphere in the confined space tested?

Was Oxygen at least 19.5% - not more than 21%?

Were toxic, flammable, or oxygen-displacing gases/vapors present?

-Hydrogen Sulfide

- Carbon Monoxide

- Methane

- Carbon Dioxide

- Other (list) _____

YES NO

MONITORING

- Will the atmosphere in the space be monitored while work is going on?*
- Continuously?*
- Periodically? (If yes, give interval: _____)*

REMEMBER - ATMOSPHERIC CHANGES OCCUR DUE TO THE WORK PROCEDURE OR THE PRODUCT STORED. THE ATMOSPHERE MAY BE SAFE WHEN YOU ENTER, BUT CAN CHANGE VERY QUICKLY.

CLEANING

- Has the space been cleaned before entry is made?*
- Was the space steamed?*
- If so, was it allowed to cool?*

VENTILATION

- Has the space been ventilated before entry?*
- Will ventilation be continued during entry?*
- Is the air intake for the ventilation system located in an area that is free of combustible dusts and vapors and toxic substances?*
- If atmosphere was found unacceptable and then ventilated, was it re-tested before entry?*

YES NO

ISOLATION

- Has the space been isolated from other systems?*
- Has electrical equipment been locked out?*
- Have disconnects been used where possible?*
- Has mechanical equipment been blocked, chocked, and disengaged where necessary?*
- Have lines under pressure been blanked and bled?*

CLOTHING/EQUIPMENT

- Is special clothing required (boots, chemical suits, glasses, etc.)?*

(If so, specify: _____)

- Is special equipment required (e.g., rescue equipment, communications equipment, etc.)?*

(If so, specify: _____)

- Are special tools required (e.g., sparkproof)?*

(If so, specify: _____)

RESPIRATORY PROTECTION

- Are MSHA/NIOSH-approved respirators of the type required available at the worksite?*

- Is respiratory protection required (e.g., air-purifying, supplied air, self-contained breathing apparatus, etc.)?*

(If so, specify type: _____)

YES NO

- Can you get through the opening with a respirator on? (If you don't know, find out before you try to enter.)*

TRAINING

- Have you been trained in proper use of a respirator?*
- Have you received first aid/CPR training?*
- Have you been trained in confined space entry and do you know what to look for?*

STANDBY/RESCUE

- Will there be a standby person on the outside in constant visual or auditory communication with the person on the inside?*
- Will the standby person be able to see and/or hear the person inside at all times?*
- Has the standby person(s) been trained in rescue procedures?*
- Will safety lines and harness be required to remove a person?*
- Are company rescue procedures available to be followed in the event of an emergency?*
- Are you familiar with emergency rescue procedures?*
- Do you know who to notify and how in the event of an emergency?*

YES NO

PERMIT

(The permit is an authorization in writing that states that the space has been tested by a qualified person, that the space is safe for entry; what precautions, equipment, etc. are required; and what work is to be done.)

- Has a confined space entry permit been issued?*
- Does the permit include a list of emergency telephone numbers?*

For further information on confined spaces, occupational hazards, safe work practices, and other topics which could affect your wellbeing, write to:

**PUBLICATIONS DISSEMINATION
National Institute for Occupational
Safety and Health
Robert A. Taft Laboratories
4676 Columbia Parkway
Cincinnati, OH 45226**

Lack of hazard awareness and unplanned rescue attempts led to the following deaths:

On July 23, 1985, a city worker was removing an inspection plate from a sewer line in a 50-foot deep pump station, when the plate blew off allowing raw sewage to enter the room. Two fellow workers and a policeman attempted to rescue the worker from the sludge filled room and were unsuccessful. All four were dead when removed from the pumping station.

On February 21, 1986, a self-employed truck driver died after entering the top of a 22-foot high x 15-foot square sawdust bin. He suffocated when the sawdust inside the bin collapsed and buried him.

On July 5, 1986, a worker entered a chemical degreaser tank to clean out the bottom and collapsed. Two fellow workers noticed the man down and went in to rescue him. All three workers died.

On July 16, 1986, a worker entered a septic tank to clean out the residue at the bottom and collapsed shortly afterward. Two workers on the outside went in to rescue the downed worker. All three were dead when removed from the tank.

On October 10, 1986, a self-employed plumbing contractor entered an underground water line vault to inspect a backflow device. The contractor collapsed shortly after entering the vault. A supervisor noticed the man down, and entered the vault in a rescue attempt. Both men had entered an untested oxygen-deficient atmosphere, and died as a result.

On February 6, 1987, two workers (father and son) at a wastewater plant were working on a digester that was being drained. They went on top of the digester and opened a hatch to check the sludge level. To provide light in the digester, they lowered an extension cord with an exposed 200 watt light bulb into the digester. The light broke and caused the methane gas in the digester to explode, killing both men instantly.

If the guidelines in this pamphlet had been followed, these fatalities would have been prevented.



What is the OSHA standard for control of hazardous energy sources?

The OSHA standard for *The Control of Hazardous Energy (Lockout/Tagout)*, Title 29 Code of Federal Regulations (CFR) Part 1910.147, addresses the practices and procedures necessary to disable machinery or equipment, thereby preventing the release of hazardous energy while employees perform servicing and maintenance activities. The standard outlines measures for controlling hazardous energies—electrical, mechanical, hydraulic, pneumatic, chemical, thermal, and other energy sources.

In addition, 29 CFR 1910.333 sets forth requirements to protect employees working on electric circuits and equipment. This section requires workers to use safe work practices, including lockout and tagging procedures. These provisions apply when employees are exposed to electrical hazards while working on, near, or with conductors or systems that use electric energy.

Why is controlling hazardous energy sources important?

Employees servicing or maintaining machines or equipment may be exposed to serious physical harm or death if hazardous energy is not properly controlled. Craft workers, machine operators, and laborers are among the 3 million workers who service equipment and face the greatest risk. Compliance with the lockout/tagout standard prevents an estimated 120 fatalities and 50,000 injuries each year. Workers injured on the job from exposure to hazardous energy lose an average of 24 workdays for recuperation.

How can you protect workers?

The lockout/tagout standard establishes the employer's responsibility to protect employees from hazardous energy sources on machines and equipment during service and maintenance.

The standard gives each employer the flexibility to develop an energy control program suited to the needs of the particular workplace and the types of machines and equipment being maintained or serviced. This is generally done by affixing the appropriate lockout or tagout devices to energy-isolating devices and by deenergizing machines and equipment. The standard outlines the steps required to do this.

What do employees need to know?

Employees need to be trained to ensure that they know, understand, and follow the applicable provisions of the hazardous energy control procedures. The training must cover at least three areas: aspects of the employer's energy control program; elements of the energy control procedure relevant to the employee's duties or assignment; and the various requirements of the OSHA standards related to lockout/tagout.

What must employers do to protect employees?

The standards establish requirements that employers must follow when employees are exposed to hazardous energy while servicing and maintaining equipment and machinery. Some of the most critical requirements from these standards are outlined below:

- Develop, implement, and enforce an energy control program.
- Use lockout devices for equipment that can be locked out. Tagout devices may be used in lieu of lockout devices only if the tagout program provides employee protection equivalent to that provided through a lockout program.
- Ensure that new or overhauled equipment is capable of being locked out.
- Develop, implement, and enforce an effective tagout program if machines or equipment are not capable of being locked out.

- Develop, document, implement, and enforce energy control procedures. [See the note to 29 CFR 1910.147(c)(4)(i) for an exception to the documentation requirements.]
- Use only lockout/tagout devices authorized for the particular equipment or machinery and ensure that they are durable, standardized, and substantial.
- Ensure that lockout/tagout devices identify the individual users.
- Establish a policy that permits only the employee who applied a lockout/tagout device to remove it. [See 29 CFR 1910.147(e)(3) for exception.]
- Inspect energy control procedures at least annually.
- Provide effective training as mandated for all employees covered by the standard.
- Comply with the additional energy control provisions in OSHA standards when machines or equipment must be tested or repositioned, when outside contractors work at the site, in group lockout situations, and during shift or personnel changes.

How can you get more information?

OSHA has various publications, standards, technical assistance, and compliance tools to help you, and offers extensive assistance through

its many safety and health programs: workplace consultation, voluntary protection programs, grants, strategic partnerships, state plans, training, and education. Guidance such as OSHA's *Safety and Health Management Program Guidelines* identify elements that are critical to the development of a successful safety and health management system. This and other information are available on OSHA's website at www.osha.gov.

- For a free copy of OSHA publications, send a self-addressed mailing label to this address: OSHA Publications Office, P.O. Box 37535, Washington, DC 20013-7535; or send a request to our fax at (202) 693-2498, or call us at (202) 693-1888.
- To file a complaint by phone, report an emergency, or get OSHA advice, assistance, or products, contact your nearest OSHA office under the "U.S. Department of Labor" listing in your phone book, or call us toll-free at **(800) 321-OSHA (6742)**. The teletypewriter (TTY) number is (877) 889-5627.
- To file a complaint online or obtain more information on OSHA federal and state programs, visit OSHA's website.

This is one in a series of informational fact sheets highlighting OSHA programs, policies, or standards. It does not impose any new compliance requirements or carry the force of legal opinion. For compliance requirements of OSHA standards or regulations, refer to *Title 29 of the Code of Federal Regulations*. This information will be made available to sensory-impaired individuals upon request. Voice phone: (202) 693-1999. See also OSHA's website at www.osha.gov.

An additional booklet on control of hazardous energy is available under the sprinkler section of Test Info page

